

I AM ACCURATE

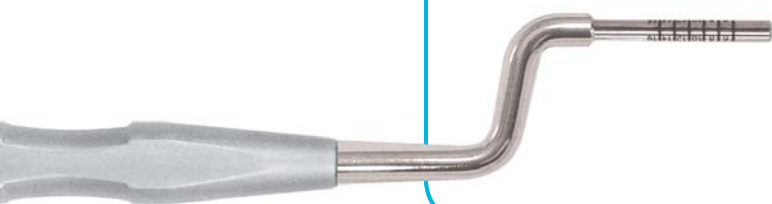

**Innovación
Calidad
Rendimiento**

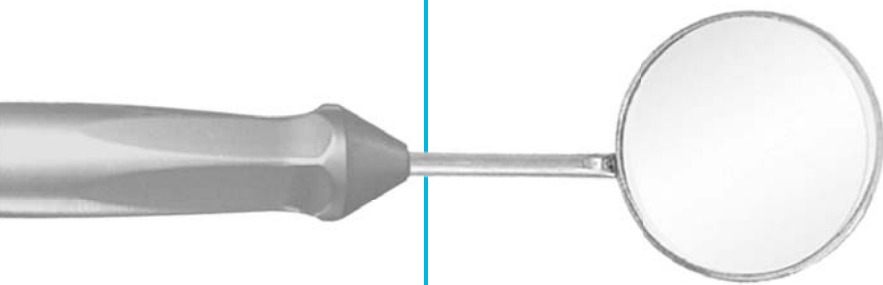

ACTEON

Prodont Holliger

El fabricante francés de instrumentos dentales Prodont Holliger fue creado por dentistas, para dentistas.

Situada en el corazón de Francia y en una región mundialmente conocida por su metalurgia y en particular, sus cuchillos, la empresa exporta en todo el mundo herramientas altamente fiables, fruto de equipos industriales de vanguardia y competencias únicas.



Prodont Holliger es conocida por su calidad refinada y profundamente inigualable y está dirigida por un equipo apasionado para quien el rigor y la precisión son palabras clave.

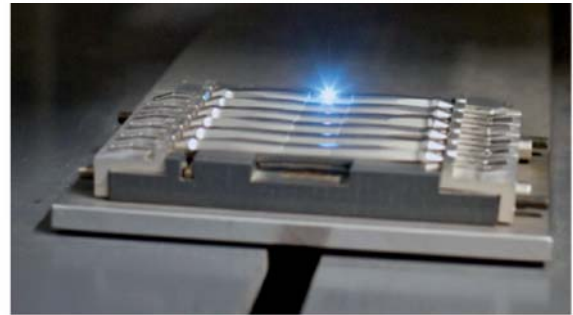

Somos los únicos fabricantes de espejos dentales quirúrgicos y otorrinolaringológicos europeos. De acuerdo con un proceso único, nuestros equipos diseñan una infinidad de modelos adaptados a todas las prácticas clínicas.

Espejo PURE REFLECT®
Cortesía de Pr. Tassery.



El mango XL-Style garantiza una excelente agarre, una higiene irreprochable y comodidad visual (acabado satinado).



Personalización en grabado láser bajo pedido, en nuestro taller.



**Hoy, Prodont Holliger y Acteon®
se unen para ofrecer a los odontólogos
toda la excelencia de sus experiencias.**

&

Acteon®, pioneros en el campo de los ultrasonidos para cuidados dentales y cirugía, se diversifica progresivamente para convertirse en un actor clave del mundo dental, particularmente en imagen médica digital.

5 equipos de I + D trabajan en estrecha colaboración para diseñar siempre más y más productos innovadores.



Se presta también una atención extrema a la precisión y calidad para garantizar a los médicos y pacientes la realización de un acto siempre menos invasivo y traumático.

ACTEON



Inspirada y diseñada para cirujanos dentales, cada herramienta está perfectamente adaptada a las necesidades clínicas.

Del diagnóstico al tratamiento,
Acteon® le ayuda en todas
sus actividades diarias.



GAMA DE ESPEJOS - 7

INSTRUMENTOS DE DIAGNÓSTICO - 21



MOLDES / PRÓTESIS - 37

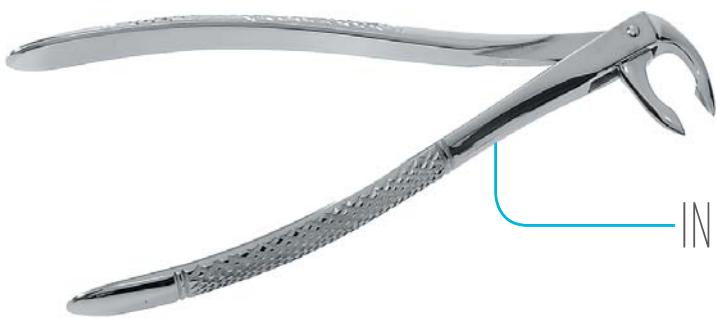

INSTRUMENTOS PARA EXTRACCIÓN - 51

INSTRUMENTOS PARA IMPLANTOLOGÍA- 69



CONTENIDO

INSTRUMENTOS PREMIUM BLISS - 15



INSTRUMENTOS PARA RESTAURACIÓN - 25



INSTRUMENTOS PARA PERIODONCIA - 41



INSTRUMENTOS PARA CIRUGÍA - 61

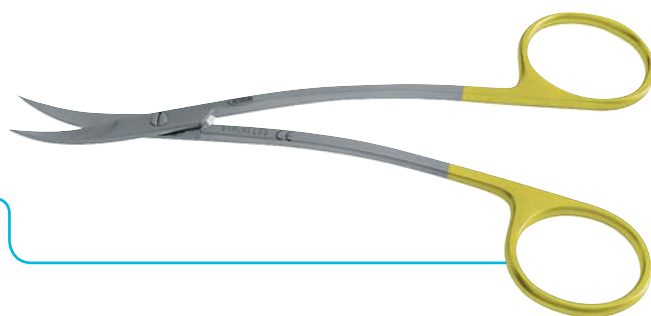

ACCESORIOS - 93



ORTODONCIA - 85





GAMA DE ESPEJOS

Espejos de Boca	9
Microespejos, Espejos Laríngeos	11
Mango Rotativo para Espejos Fotográficos	12
Espejos Fotográficos de Doble Cara	13
Mangos para Espejos	14

ESPEJOS

ESPEJOS ACTEON PRODONT-HOLLIGER

REFLEJO EN CAPA INFERIOR (aluminio)

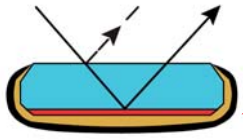

Metal depositado bajo el vidrio llamado "capa posterior" (efecto de imagen doble).

REFLEJO EN CAPA SUPERIOR

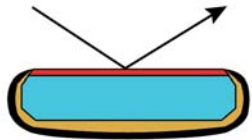

Metal depositado en el vidrio llamado "capa superior" (visión directa, sin distorsión).

Nuestros 3 tipos de espejos de superficie frontal ACTEON PRODONT-HOLLIGER

PURE REFLECT®
Imagen muy clara.
Perfecto para todas las necesidades.

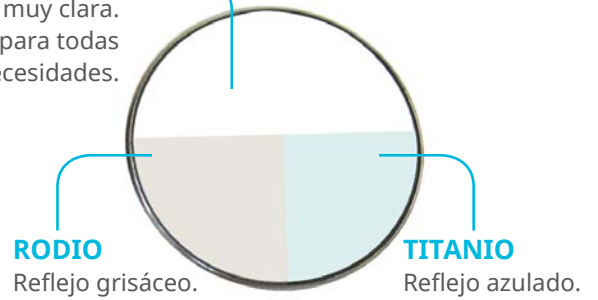

ALTERACIÓN DE LA TEMPERATURA DE COLOR

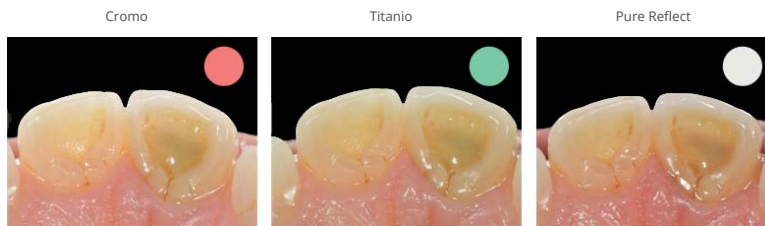

ALTERACIÓN DE LA LUMINOSIDAD



CURVAS DE REFLEJO

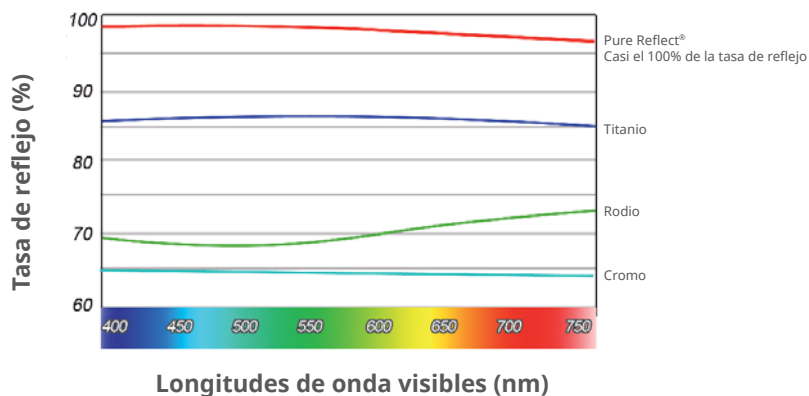

ESPEJOS

ESPEJOS DE BOCA

ESPEJOS DE BOCA CONE SOCKET



La rosca Cone Socket tiene un diámetro de rosca más grande (utilizado principalmente en **España**, EE.UU., Canadá y Corea del Sur).

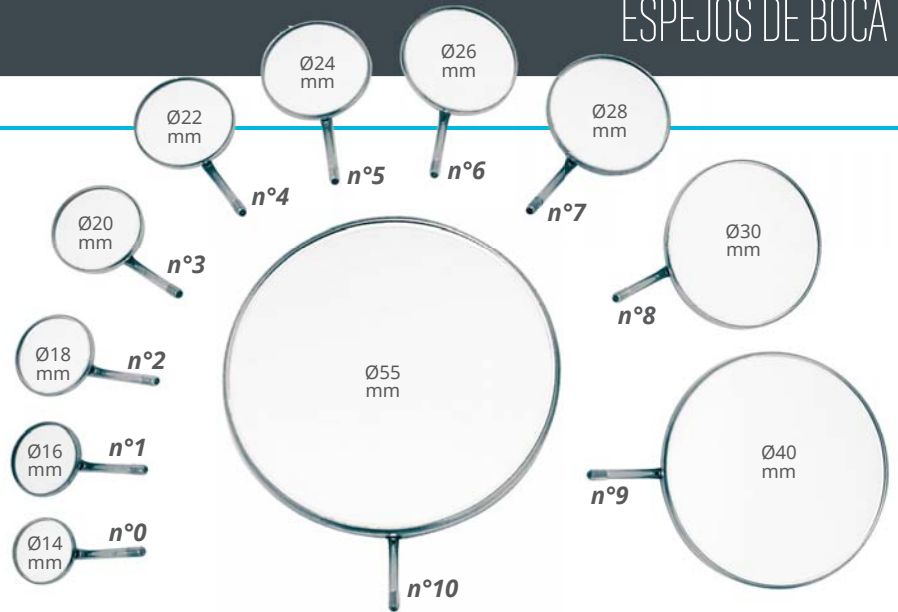

PLANO

ALUMINIO			RODIO			TITANIO			PURE REFLECT®		
Nº	REF.	Cant.	Nº	REF.	Cant.	Nº	REF.	Cant.	Nº	REF.	Cant.
2	MP4118PH	12	2	MP4318PH	12	3	MP4520PH	12	1	MP4614PH	12
3	MP4120PH	12	3	MP4320PH	12	4	MP4522PH	12	2	MP4618PH	12
4	MP4122PH	12	4	MP4322PH	12	5	MP4524PH	12	3	MP4620PH	12
5	MP4124PH	12	5	MP4324PH	12	8	MP4530PH	1	4	MP4622PH	12
6	MP4126PH	12	6	MP4326PH	12				5	MP4624PH	12
7	MP4128PH	1	7	MP4328PH	1				6	MP4626PH	12
8	MP4130PH	1	8	MP4330PH	1				9	MP4640PH	1
9	MP4140PH	1	9	MP4340PH	1				10	MP4655PH	1
10	MP4155PH	1	10	MP4355PH	1						

MAGNIFICACIÓN x3,5

ALUMINIO			RODIO		
Nº	REF.	Cant.	Nº	REF.	Cant.
2	MP4218PH	12	4	MP4422PH	12
3	MP4220PH	12	5	MP4424PH	12
4	MP4222PH	12			
5	MP4224PH	12			
6	MP4226PH	12			
7	MP4228PH	1			
8	MP4230PH	1			

Existen multitud de espejos en versión **"SINGLE SOCKET"**.

Consúltenos para más información sobre nuestros espejos en versión "SINGLE SOCKET".

ESPEJOS DE DOBLE CARA DE ROSCA CONE SOCKET



- Gracias a las 2 caras reflectantes opuestas, no es necesario girar el espejo para ir de derecha a izquierda en la boca.
- Montura adaptada a la cavidad bucal, utilizado como retractor.

RODIO			TITANIO			PURE REFLECT®		
Nº	REF.	Cant.	Nº	REF.	Cant.	Nº	REF.	Cant.
4	MP8322PH	12	4	MP8522PH	12	4	MP8722PH	12
5	MP8324PH	12	5	MP8524PH	12	5	MP8724PH	12
4	MPP8322PH	6				4	MP8822PH	6
5	MPP8324PH	6				5	MP8824PH	6

ESPEJOS

ESPEJOS DE BOCA

ESPEJO MILIMÉTRICO

► Espejo de medición, perfecto para comprobar el paralelismo en cirugía de implantes.

P5 Ø 24 mm.

REF. MP3000P (Single Socket)

REF. MP4000P (Cone Socket)



ESPEJOS DE COLORES



Ø22 mm, cuerpo de plástico.
ESTERILIZABLES.

7 colores.

36 espejos de aluminio.

REF. MP8122MPH

PROTECCIÓN ANTIVAHO PARA ESPEJOS



EFICIENCIA INCOMPARABLE

- Pulverizar.
- Limpiar.
- Listo para usar.

REF. ABF
100 ml

GAMA DE ESPEJOS HOLY, HOLY-CLAR Y DMS

Empaquetado y protegido individualmente.



HOLY ALUMINIO

HOLY-CLAR ALUMINIO Tratamiento antivaho.

Nº	REF.	Cant.		Nº	REF.	Cant.
4	MP105122PH	12	PLAN	4	MP105222PH	12
5	MP105124PH	12		5	MP105224PH	12
4	MP105322PH	12	MAGNIFICACIÓN x3,5	4	MP105422PH	12
5	MP105324PH	12		5	MP105424PH	12

DMS ALUMINIO

Caja de Plexiglas con espacios individuales.

DMS RODIO



Nº	REF.	Cant.		Nº	REF.	Cant.
4	MP103122PH	12	PLAN	4	MP103322DMS	12
5	MP103124PH	12		5	MP103324DMS	12
4	MP103222PH	12	MAGNIFICACIÓN x3,5	4	MP103422PH	12
5	MP103224PH	12		5	MP103424PH	12



ESPEJOS

MICROESPEJOS

MICROESPEJOS PURE REFLECT® DE ROSCA CONE SOCKET

Operaciones con lupa o microscopio, utilizados en endo y retro.
¡Nuestros microespejos satisfacen sus necesidades!



Para enroscar con el mango estándar (p14).



Consúltenos para información sobre nuestros microespejos en versión "SINGLE SOCKET".

Ø3 mm
REF. MP1303PH

Ø5 mm
REF. MP1305PH

7x2 mm
REF. MP1306RPH

9x3 mm
REF. MP1310RPH



ESPEJOS LARÍNGEOS DE ROSCA SIMPLE

ROSCADO

ALUMINIO			RODIO		
Nº	REF.	Cant.	Nº	REF.	Cant.
000	MP2110	1	000	MP2310	1
00	MP2112	1	00	MP2312	1
0	MP2114	1	0	MP2314	1
1	MP2116	1	1	MP2316	1
2	MP2118	1	2	MP2318	1
3	MP2120	1	3	MP2320	1
4	MP2122	1	4	MP2322	1
5	MP2124	1	5	MP2324	1
6	MP2126	1	6	MP2326	1
7	MP2128	1	7	MP2328	1
8	MP2130	1			

LISO

ALUMINIO			RODIO		
Nº	REF.	Cant.	Nº	REF.	Cant.
000	MP1110PH	1	000	MP1310PH	1
00	MP1112PH	1	00	MP1312PH	1
0	MP1114PH	1	0	MP1314PH	1
1	MP1116PH	1	1	MP1316PH	1
2	MP1118PH	1	2	MP1318PH	1
3	MP1120PH	1	3	MP1320PH	1
4	MP1122PH	1	4	MP1322PH	1
5	MP1124PH	1	5	MP1324PH	1
6	MP1126PH	1	6	MP1326PH	1
7	MP1128PH	1	7	MP1328PH	1
8	MP1130PH	1	8	MP1330PH	1

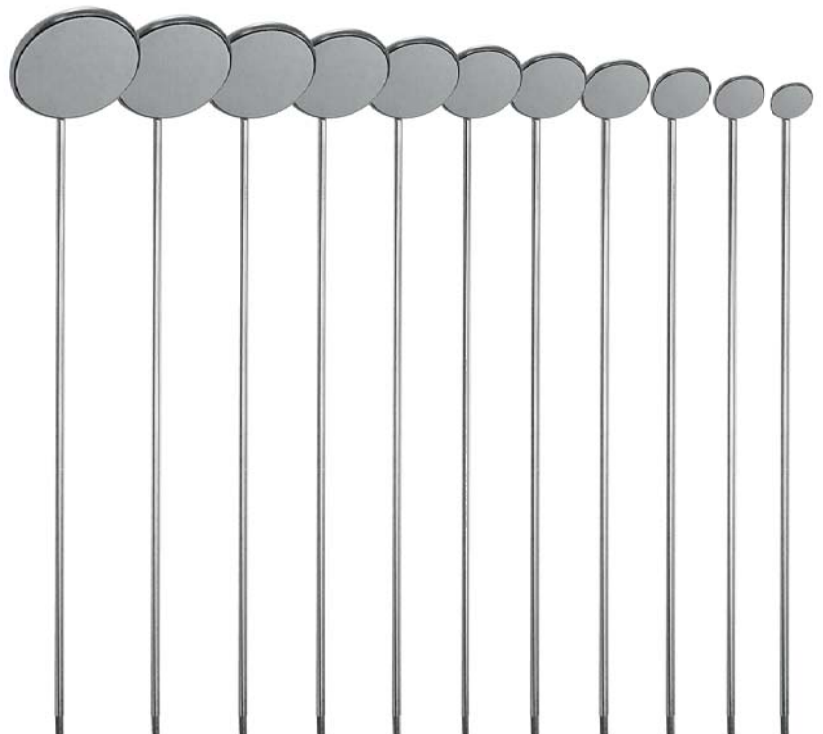

Mango para espejos laríngeos, P14.

Longitud: 140 mm.

ESPEJOS

MANGO ROTATIVO PARA ESPEJOS FOTOGRÁFICOS

MANGO ROTATIVO PARA ESPEJOS FOTOGRÁFICOS



REF. MZP214.

L. 148 mm, Ø 15-20 mm, 107 g, Rot. 70°

De aluminio anodizado, ligeramente en forma de cono. La parte superior articulada permite realizar fotos en diferentes posiciones sin tocar el espejo.

Se suministra con una llave para apretar y asegurar la cabeza desmontable. De esta manera, el mango tiene una utilidad espaciadora.

Compatible con todos nuestros espejos fotográficos. Los espejos encajan y se retiran fácilmente.



RETRACTORES DE MEJILLA



Tamaño adulto
REF. 151.40



Tamaño niño
REF. 151.41

ESPEJOS

ESPEJOS FOTOGRÁFICOS DE DOBLE CARA

ESPEJOS FOTOGRÁFICOS DE DOBLE CARA

CONTRASTADORES

Nº 4 recto,
modelo pequeño.
240x60 mm
REF. MZP215



Nº 5 recto,
modelo grande.
240x60 mm
REF. MZP216

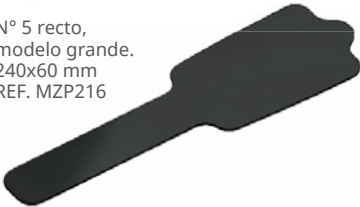

Nº 3 simple
70x73x1,5 mm
REF. MZP217



Nº 1 angulado,
modelo pequeño.
118x85x84 mm
REF. MZP218



Nº 2 angulado,
modelo grande.
120x70x59 mm
REF. MZP219



Espesor: 1,5 mm.
Material: aluminio.

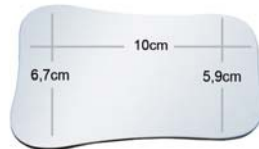

Superficie Oclusal Adulto

Titanio - REF. MZP511.
Cromo - REF. MZP512.
Pure Reflect® - REF. MZP516.

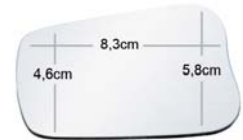

Superficie Oclusal Niño

Titanio - REF. MZP521.
Cromo - REF. MZP522.
Pure Reflect® - REF. MZP526.



Superficie vestibular

Titanio - REF. MZP531.
Cromo - REF. MZP532.
Pure Reflect® - REF. MZP536.

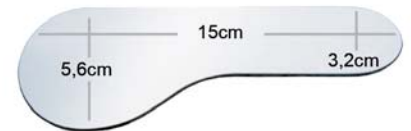

Superficie Lingual Fina

Titanio - REF. MZP541.
Chrome - REF. MZP542.
Pure Reflect® - REF. MZP546.



Superficie Lingual Grande

Titanio - REF. MZP551.
Cromo - REF. MZP552.
Pure Reflect® - REF. MZP556.



Superficie Lateral

Titanio - REF. MZP561.
Cromo - REF. MZP562.
Pure Reflect® - REF. MZP566.

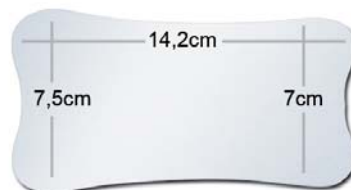

Superficie Oclusal Grande

Titanio - REF. MZP571.
Cromo - REF. MZP572.
Pure Reflect® - REF. MZP576.

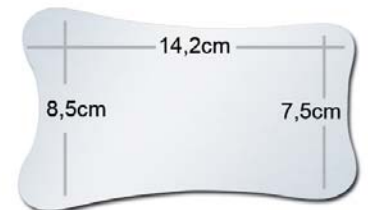

Superficie Oclusal Extra Grande

Titanio - REF. MZP581.
Cromo - REF. MZP582.
Pure Reflect® - REF. MZP586.

Bandeja para espejos fotográficos.

para 3 espejos o
2 espejos + mango.
REF. 233.19

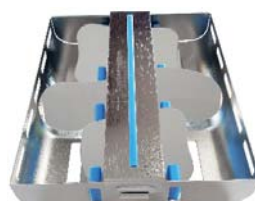
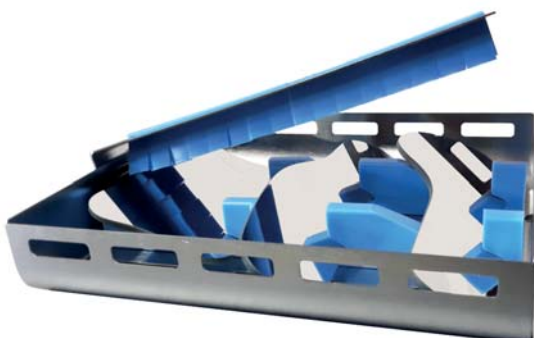

Los espejos y mango se venden por separado.

ESPEJOS

MANGOS PARA ESPEJOS

MANGOS PARA ESPEJOS



mango XL Style

REF. 210.00XL (Single Socket)
REF. 212.00XL (Cone Socket)



mango Design

REF. 210.00D (Single Socket)
REF. 212.00D (Cone Socket)



REF. 210.00 (Single Socket)
REF. 212.00 (Cone Socket)



REF. 13313 (Single Socket)



REF. 210.01 (Single Socket)



REF. 219.00 (Single Socket)



REF. MP43815 (Single Socket)

MANGOS PARA ESPEJOS LARÍNGEOS



Para espejo con varilla roscada.
7,5 cm

REF. 15231
(Single Socket)



Para espejo con varilla lisa.
10 cm

REF. 216.00
(Single Socket)

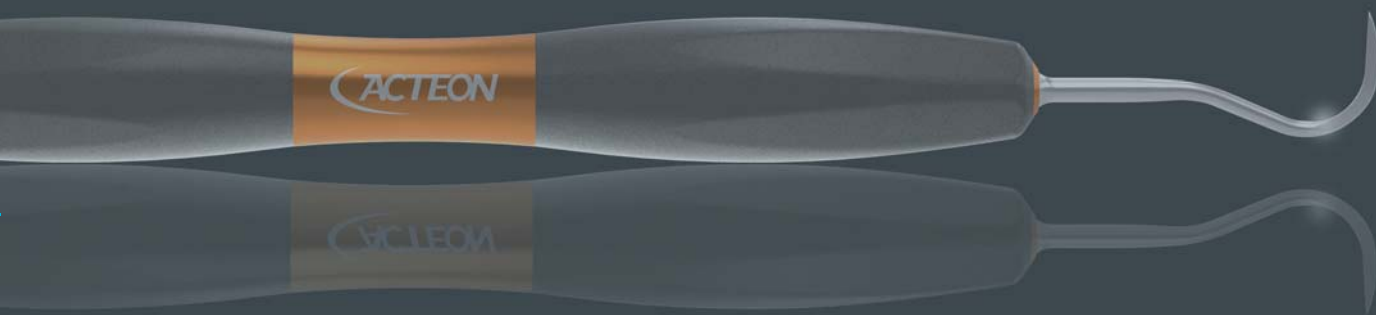

INSTRUMENTOS PREMIUM BLISS

Curetas Gracey.....	16
Curetas Universales.....	17
Hoces.....	17
Extremos Dobles.....	17
Sondas para Diagnóstico.....	18
Excavadores.....	18
Espátulas para Cemento.....	18
Mangos de Espejo.....	18
Espátulas de Modelado.....	19
Sondas para Periodoncia.....	19
Pluggers.....	20

INSTRUMENTOS PREMIUM

Bliss
by Acteon

LA PRÓXIMA GENERACIÓN DE INSTRUMENTOS MANUALES

- Comodidad revolucionaria en la punta de sus dedos.
- Precisión y calidad excepcionales.
- Tacto suave y agarre único.
- Mango ergonómico y cómodo con solo 15 gr. de peso.
- Excelentes bordes afilados, de larga duración.

CURETAS GRACEY

MARQUE LA DIFERENCIA...

Basado en los estándares originales de los diseños de curetas Gracey, Acteon® trabajó en estrecha colaboración con higienistas dentales para diseñar los vástagos y los extremos de trabajo de cada instrumento para maximizar su rendimiento y eficiencia.

Gracey 1-2
REF. 402.01SI



Gracey 5-6
REF. 402.05SI



Gracey 11-12
REF. 402.11SI



Gracey 13-14
REF. 402.13SI



Gracey 15-16
REF. 402.15SI



Gracey 17-18
REF. 402.17SI



INSTRUMENTOS PREMIUM

CURETAS UNIVERSALES

SE MERECE LA MEJOR COMODIDAD

El agarre suave de silicona permite un gesto controlado y firme.



HOCES

ACCESO A SUPERFICIES INTERPROXIMALES ESTRECHAS

Las curetas de hoz Bliss están diseñadas para proporcionar acceso interproximal a los dientes anteriores y posteriores. El extremo terminal más delgado de la cuchilla facilita el acceso en áreas de difícil alcance.



EXTREMOS DOBLES

DOBLE EFICIENCIA, DOBLE RENDIMIENTO

Encuentre el beneficio de la cureta fina y la cureta universal Langer 5.



INSTRUMENTOS PREMIUM

DIAGNÓSTICO (SONDAS)

11-12
REF. 263.06SI



17-23
REF. 263.07SI



RESTAURACIÓN (EXCAVADORES)

36-35
REF. 165.01SI



38-37
REF. 165.02SI



91
REF. 165.03SI



125
REF. 108.14SI



RESTAURACIÓN (ESPÁTULAS PARA CEMENTO)

20 mm.
REF. 246.05SI



25 mm.
REF. 246.09SI



50 mm.
REF. 246.24SI



MANGO DE
ESPEJO
REF. 212.00SI (CSS)
REF. 210.00SI (SS)

INSTRUMENTOS PREMIUM

RESTAURACIÓN (ESPÁTULAS DE MODELADO)



PERIODONCIA (SONDAS)



INSTRUMENTOS PREMIUM

ENDODONCIA (PLUGGERS)

MACHTOU 1-1
REF. 419.01SI



MACHTOU 1-2
REF. 419.02SI



MACHTOU 2-3
REF. 419.03SI



MACHTOU 2-4
REF. 419.04SI



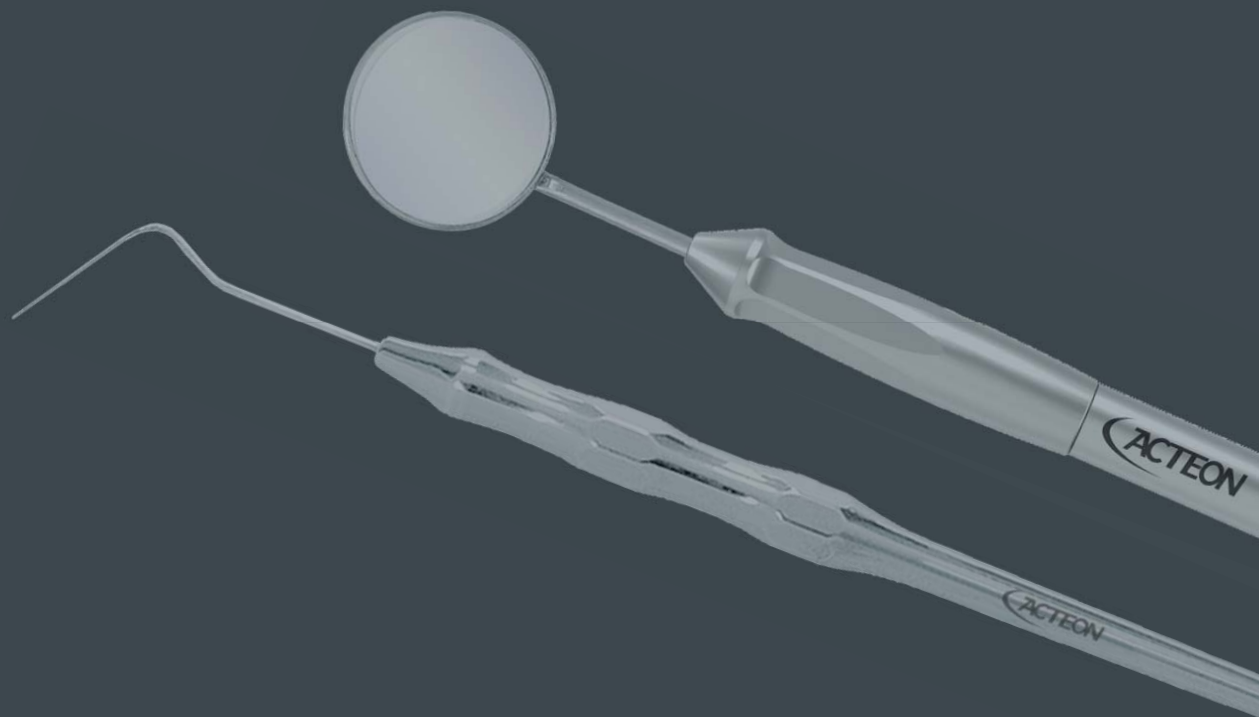

INSTRUMENTOS DE DIAGNÓSTICO

Kits de Examen y Cuidado.....	22
Pinzas.....	23
Sondas.....	24

DIAGNÓSTICO

KITS DE EXAMEN Y CUIDADO

KIT DE EXAMEN DE 3 INSTRUMENTOS CONE SOCKET



mango **XL Style**

REF. 500.01XL

Compuesto de:

- 1 Mango XL - REF. 212.00XL
- 1 Espejo alum. talla 4 - REF. MP4122PH
- 1 Sonda con mango XL - REF. 262.20XL
- 1 Pinza College - REF. 220.02S.



mango **Design**

REF. 500.01D

Compuesto de:

- 1 Mango D - REF. 212.00D
- 1 Espejo alum. talla 4 - REF. MP4122PH
- 1 Sonda con mango D - REF. 262.20D
- 1 Pinza College - REF. 220.02.



mango **Design**

REF. 500.IBD

Compuesto de:

- 1 Mango D - REF. 212.00D
- 1 Espejo Pure Reflect talla 5 - REF. MP4624PH
- 1 Sonda doble con mango D - REF. 263.05D
- 1 Pinza College - REF. 220.02.

KIT DE CUIDADO DE 4 INSTRUMENTOS CONE SOCKET



mango **XL Style**

REF. 501.01XL

Compuesto de:

- 1 Mango XL - REF. 212.00XL
- 1 Espejo alum. talla 4 - REF. MP4122PH
- 1 Sonda con mango XL - REF. 262.09XL
- 1 Espátula H.E.I. n°1 con mango XL - REF.193.01XL
- 1 Pinza College - REF. 220.02S.



mango **Design**

REF. 501.01D

Compuesto de:

- 1 Mango D - REF. 212.00D
- 1 Espejo alum. talla 4 - REF. MP4122PH
- 1 Sonda con mango D - REF. 262.09D
- 1 Espátula H.E.I. n°1 con mango D - REF.193.01D
- 1 Pinza College - REF. 220.02.

DIAGNÓSTICO

PINZAS

PINZAS



COLLEGE 15 cm
REF. 219.01



COLLEGE 15 cm
REF. 219.02



COLLEGE 15 cm
REF. 220.01



COLLEGE 15 cm
REF. 220.02.



COLLEGE 15 cm SATINADA
REF. 220.02S.



COLLEGE 15 cm
REF. 221.05



PERRY 13 cm
REF. 222.01



PERRY 13 cm
REF. 222.02



PERRY 13 cm
REF. 222.03



FLAGG 16 cm
REF. 223.00



MERIAM 16 cm
REF. 227.00

PINZAS DE BLOQUEO AUTOMÁTICO



15 cm
REF. 227.02



15 cm fina con muescas.
REF. 227.04

DIAGNÓSTICO

SONDAS

SONDAS SIMPLES



XL Style



Design

SONDAS ESPECIALES



Punta fina.



REF. 262.24XL
REF. 262.24D

SONDAS DOBLES





INSTRUMENTOS PARA RESTAURACIÓN

Espátulas para Sellado y Modelado.....	26
Espátulas Dobles para Sellado y Modelado	27
Instrumentos Dobles para Amalgama.....	28
Puntas para Amalgama.....	29
Puntas Dobles	30
Instrumentos para Tallado.....	31
Instrumentos para Retracción Gingival.....	32
Bruñidores	33
Excavadores.....	34
Espátulas para Cemento.....	35

RESTAURACIÓN

ESPÁTULAS PARA SELLADO Y MODELADO

ELIJA SU MANGO

Los instrumentos están disponibles opcionalmente con el mango **XL Style** o el mango **Design**.



XL Style REF. terminandas en XL.



Design REF. terminandas en D.

WHITE (W.H.E.)

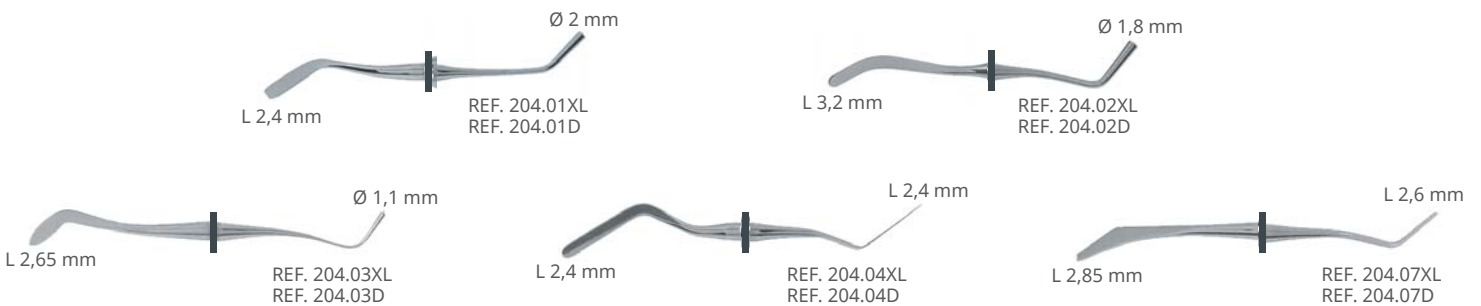

WILLIAM DIRIGO (W.D.)

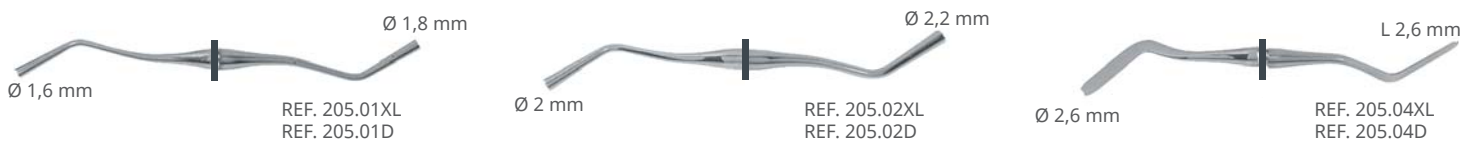

SPECIAL (L.S.P.)

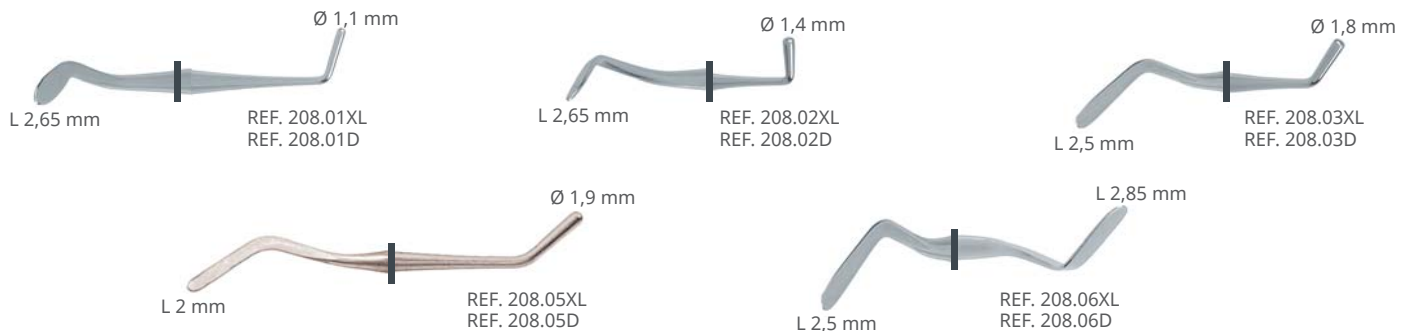

COMPOSITE DE SUPERFICIE PROXIMAL

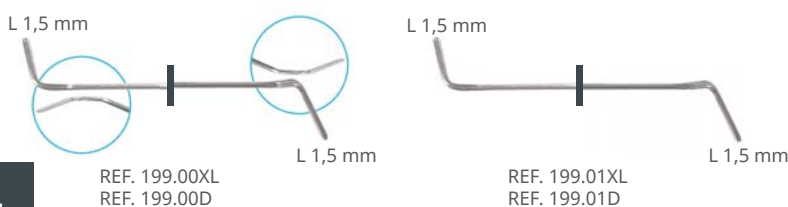

RESTAURACIÓN

ESPÁTULAS DOBLES PARA SELLADO Y MODELADO

HEIDEMANN (H.E.I.)

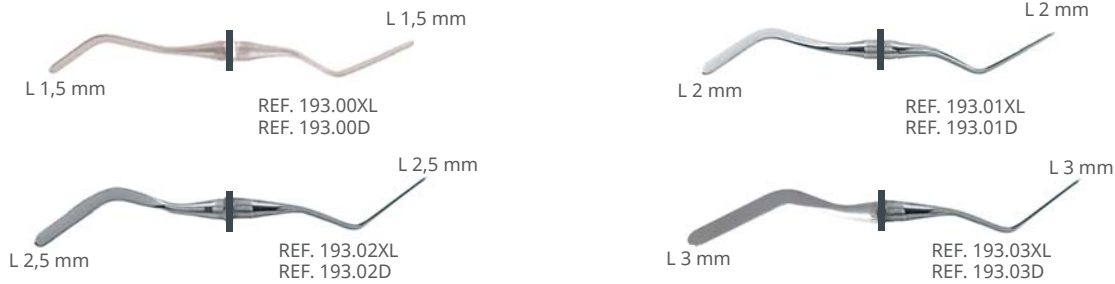

(N.P.H.)



NUEVO REVESTIMIENTO: NITRURO DE ZIRCONIO (ZRN)

Sin adhesión de cemento de ionómeros de vidrio y composites en instrumentos.

Biocompatible: no tóxico, no irritante, no sensibilizante.



HEIDEMANN (H.E.I.)

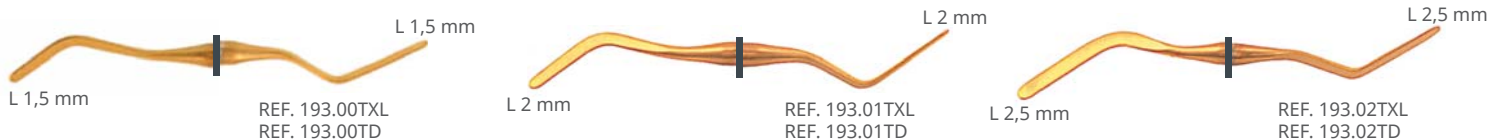

SPECIAL (L.S.P.)

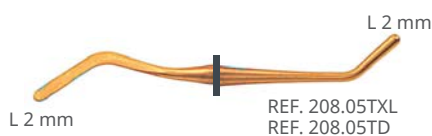

(N.P.H.)

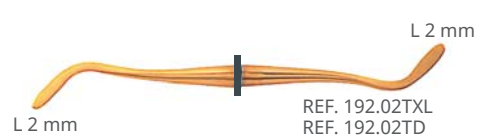

RESTAURACIÓN

INSTRUMENTOS DOBLES PARA AMALGAMA

ELIJA SU MANGO

Los instrumentos están disponibles opcionalmente con el mango **XL Style** o el mango **Design**.



XL Style REF. terminandas en XL.



Design REF. terminandas en D.

BOYD WALLIS (B.W.)



REF. 206.01XL
REF. 206.01D



REF. 206.02XL
REF. 206.02D



REF. 206.03XL
REF. 206.03D



REF. 206.04XL
REF. 206.04D



REF. 206.05XL
REF. 206.05D

WOODSON

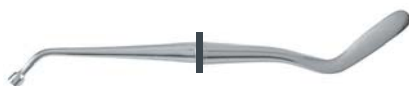

REF. 207.02XL
REF. 207.02D



REF. 207.03XL
REF. 207.03D

WESTCOTT



Ø2,4 mm
REF. 201.21XL
REF. 201.21D



Ø2,9 mm
Ø3 mm
REF. 201.22XL
REF. 201.22D

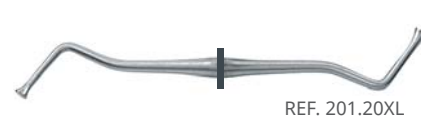

REF. 201.20XL
REF. 201.20D

LADMORE (L.A.D.)



REF. 209.02XL*
REF. 209.02D*

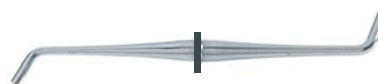

REF. 209.03XL*
REF. 209.03D*

JLM 6 ED

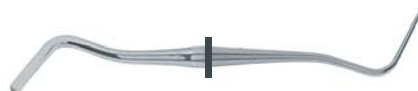

REF. 259.06XL*
REF. 259.06D*

RESTAURACIÓN

PUNTAS PARA AMALGAMA

PUNTAS DOBLES F.O.C

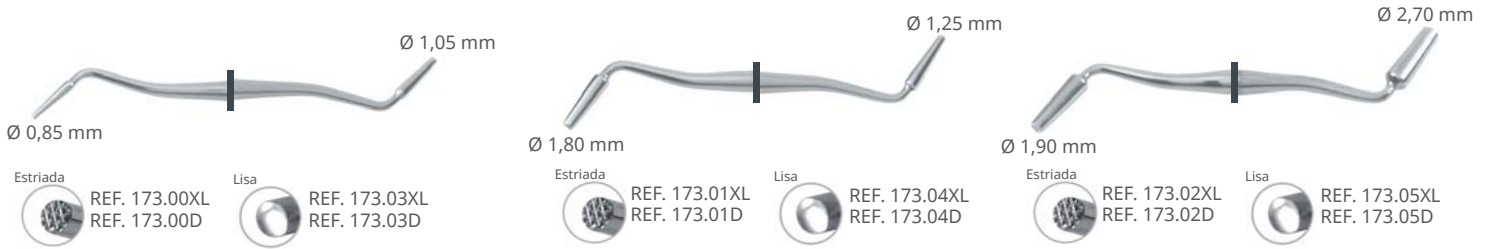

PUNTAS DOBLES

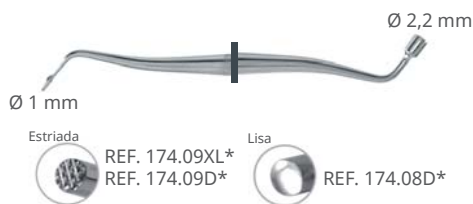

PUNTAS DOBLES MORTONSON

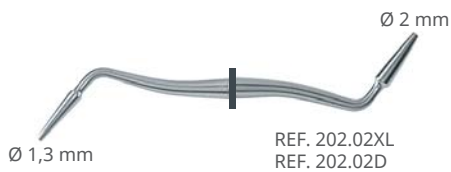

PUNTAS SIMPLES



ELIJA SU MANGO

Los instrumentos están disponibles opcionalmente con el mango **XL Style** o el mango **Design**.



XL Style REF. terminandas en XL.



Design REF. terminandas en D.

RESTAURACIÓN

PUNTAS DOBLES

ELIJA SU MANGO

Los instrumentos están disponibles opcionalmente con el mango **XL Style** o el mango **Design**.



XL Style REF. terminandas en XL.



Design REF. terminandas en D.

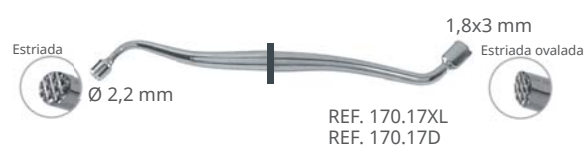
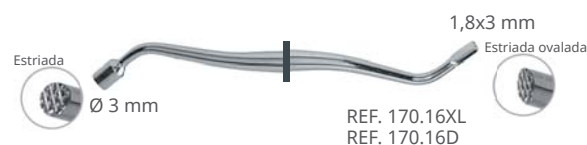
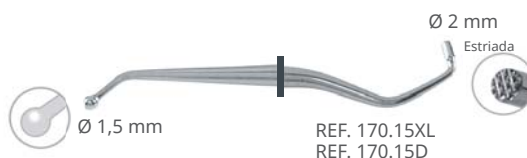
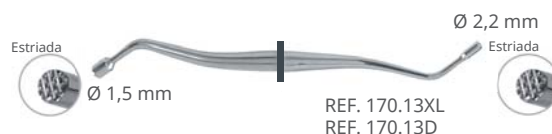
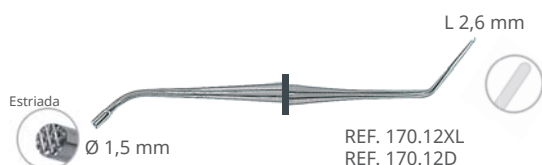
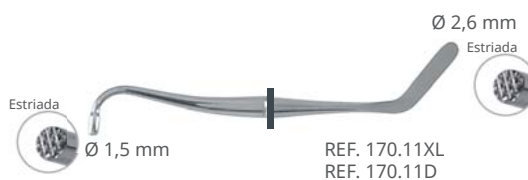
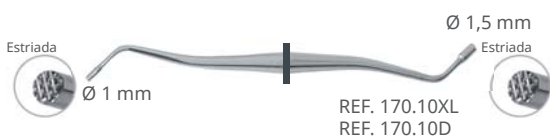

PUNTAS PARA EUGENATO

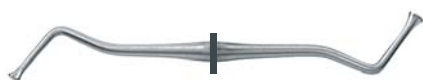

REF. 201.20XL
REF. 201.20D

INSTRUMENTOS PARA BANDAS TEMPORALES, CORONAS Y PUENTES Y FONDO DE CAVDIDAD

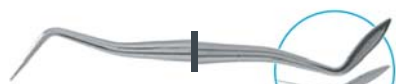

REF. 170.00XL
REF. 170.00D



REF. 170.01XL
REF. 170.01D



REF. 170.02XL
REF. 170.02D

RESTAURACIÓN

INSTRUMENTOS PARA TALLADO

ROMEROWSKI

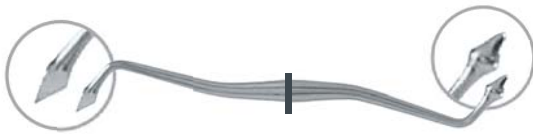

REF. 404.04XL

HOLLEMBACK



L 2,6 mm

REF. 191.03XL
REF. 191.03D

L 1,7 mm

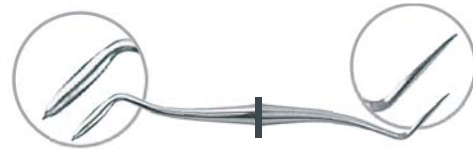

L 1,7 mm

REF. 191.04XL
REF. 191.04D

L 1,7 mm

UWD / DISCOÏD CLEOÏD



L 2,1 mm

REF. 186.05XL
REF. 186.05D

L 2,3 mm

CLEOÏD

ELIJA SU MANGO

Los instrumentos están disponibles opcionalmente con el mango **XL Style** o el mango **Design**.



XL Style REF. terminandas en XL.



Design REF. terminandas en D.



L 2,3 mm

REF. 186.89XL
REF. 186.89D



L 2,8 mm

REF. 186.92XL
REF. 186.92D



L 2,1 mm

REF. 186.93XL
REF. 186.93D

RESTAURACIÓN

INSTRUMENTOS PARA RETRACCIÓN GINGIVAL

INSTRUMENTOS PARA RETRACCIÓN GINGIVAL GINGIPROTECT®



Por fin un instrumento sencillo y fácil de usar... para la preparación de los márgenes cervicales. Dos acciones simultáneas:

- Protección eficaz de la encía marginal.
- Acceso directo y preciso a los márgenes.

GingiProtect® se utiliza como complemento de las pastas y los hilos de retracción, así como para cualquier situación en la que sea necesario un acceso a esta zona (cavidad Clase V ...).



Vea el video clínico en



INSTRUMENTOS PARA HILOS DE RETRACCIÓN GINGIVAL

ELIJA SU MANGO

Los instrumentos están disponibles opcionalmente con el mango **XL Style** o el mango **Design**.



XL Style REF. terminandas en XL.



Design REF. terminandas en D.



Con muescas

REF. 154.02XL
REF. 154.02D



Sin muescas

REF. 154.03XL
REF. 154.03D

RESTAURACIÓN

BRUÑIDORES

BRUÑIDORES DOBLES

ELIJA SU MANGO

Los instrumentos están disponibles opcionalmente con el mango **XL Style** o el mango **Design**.



XL Style REF. terminandas en XL.



Design REF. terminandas en D.



REF. 108.15XL
REF. 108.15D



REF. 108.16XL
REF. 108.16D



REF. 108.17XL
REF. 108.17D



REF. 170.48XL
REF. 170.48D

BENETT



REF. 111.00XL
REF. 111.00D

BRUÑIDORES SIMPLES

ELIJA SU MANGO

Los instrumentos están disponibles opcionalmente con el mango **XL Style** o el mango **Design**.



XL Style REF. terminandas en XL.



Design REF. terminandas en D.



REF. 106.28XL
REF. 106.28D



REF. 106.29XL
REF. 106.29D



REF. 107.32XL
REF. 107.32D



REF. 107.33XL
REF. 107.33D



REF. 107.34XL
REF. 107.34D

RESTAURACIÓN

EXCAVADORES

ELIJA SU MANGO

Los instrumentos están disponibles opcionalmente con el mango **XL Style** o el mango **Design**.



XL Style REF. terminandas en XL.



Design REF. terminandas en D.

EXCAVADORES DARBY-PERRY

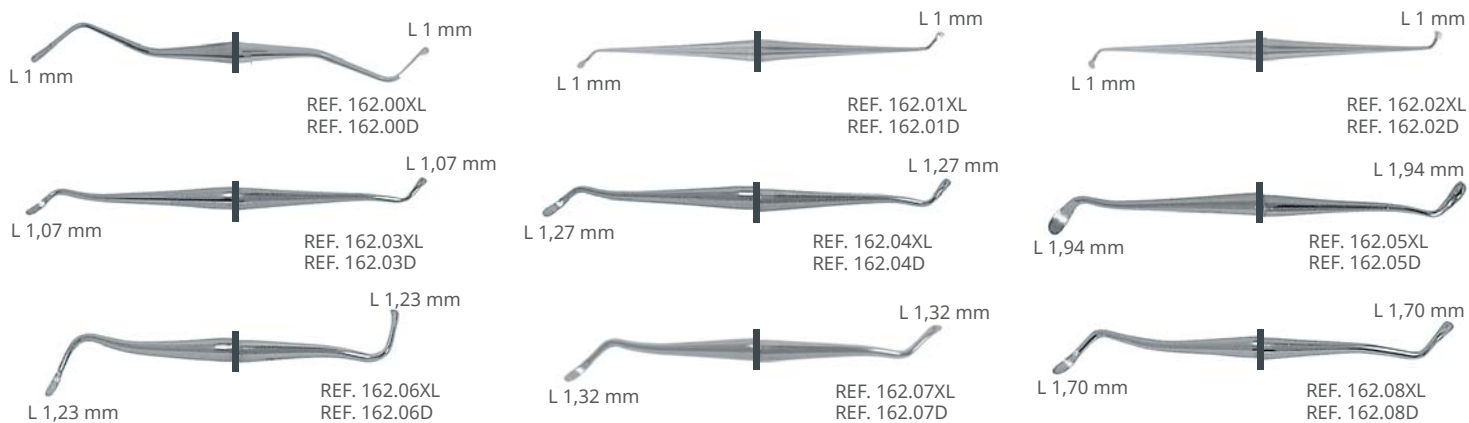

EXCAVADORES DOBLES WHITE D.E.E.

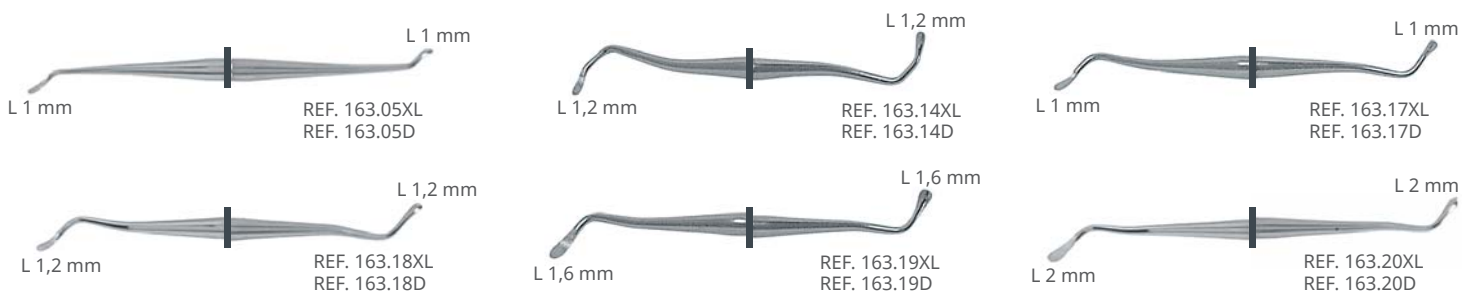

EXCAVADORES DOBLES ASH

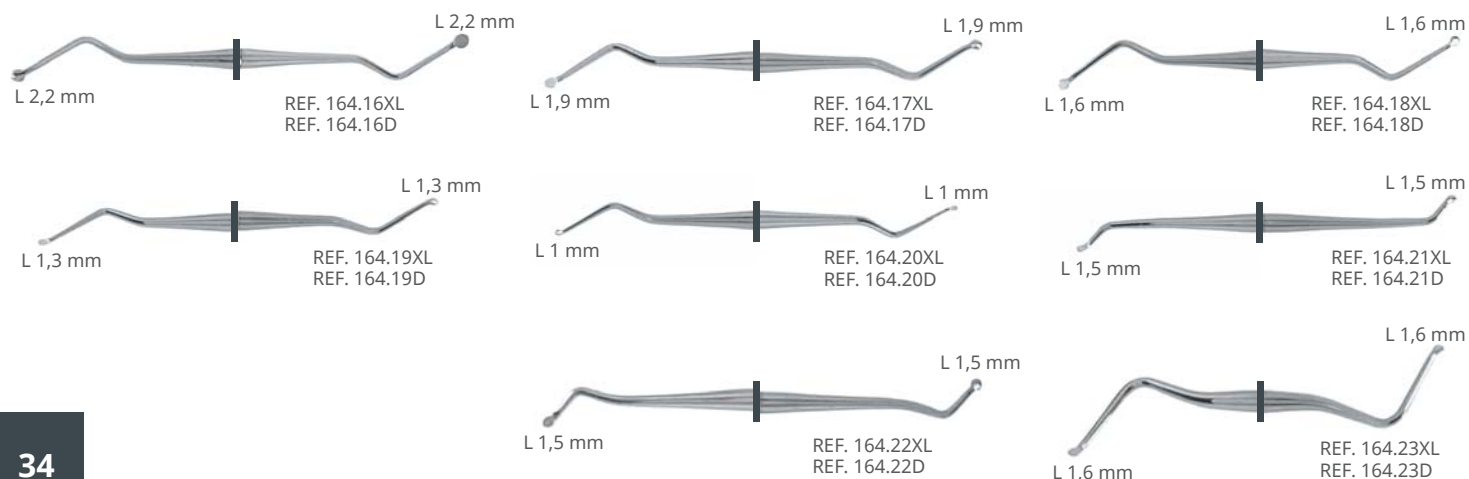

RESTAURACIÓN

ESPÁTULAS PARA CEMENTO

ELIJA SU MANGO

Los instrumentos están disponibles opcionalmente con el mango **XL Style** o el mango **Design**.



XL Style REF. terminandas en XL.



Design REF. terminandas en D.

ESPÁTULAS PARA CEMENTO SIMPLES



REF. 246.10XL
REF. 246.10D



REF. 246.11XL
REF. 246.11D



REF. 246.13XL
REF. 246.13D



REF. 246.17XL
REF. 246.17D

ESPÁTULAS ULTRAFLEXIBLES



REF. 246.18XL
REF. 246.18D



REF. 246.18TXL*
REF. 246.18TD*



REF. 246.19XL
REF. 246.19D



REF. 246.20XL
REF. 246.20D



REF. 246.20TXL*
REF. 246.20TD*

*Hasta fin de existencias.

ESPÁTULAS PARA CEMENTO DOBLES



REF. 252.01XL
REF. 252.01D



REF. 252.05XL
REF. 252.05D



REF. 252.02XL
REF. 252.02D



REF. 252.06XL
REF. 252.06D



REF. 252.03XL
REF. 252.03D



REF. 252.07XL
REF. 252.07D



REF. 252.04XL
REF. 252.04D



REF. 252.16XL
REF. 252.16D

RECIPIENTES DAPPEN

RECIPIENTE DE VIDRIO DAPPEN



10 ml / 2 ml

REF. 1592.00

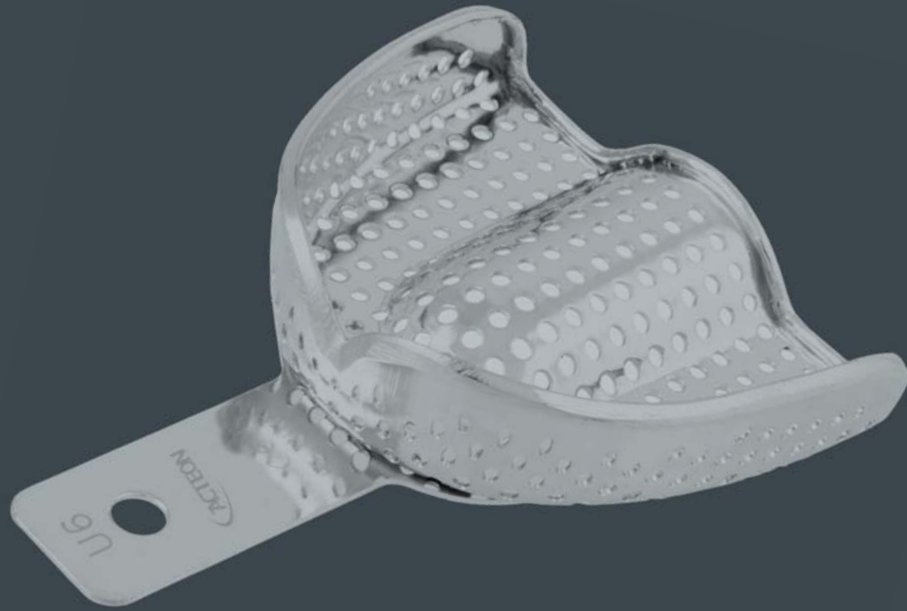

MOLDES / PRÓTESIS

Cubetas	38
Moldes, Emisor de Coronas / Instrumentos para prótesis	40

PRÓTESIS

CUBETAS

Nº2 BORDES RETENIDOS

SUPERIOR



IDEAL PARA ALGINATO

INFERIOR

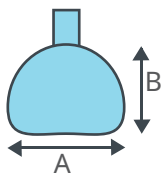

Tamaño mm.	REF.	Tamaño estándar
61x47	3041.U1	1
64x51	3041.U2	2
66x53	3041.U3	3
69x57	3041.U4	4
71x60	3041.U5	5
73x62	3041.U6	6

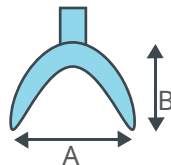

Tamaño mm.	REF.	Tamaño estándar
55x47	3041.L1	1
60x49	3041.L2	2
72x54	3041.L3	3
75x57	3041.L4	4
76x59	3041.L5	5
78x61	3041.L6	6

Nº3 BORDES COMPLETOS Y RETENIDOS

SUPERIOR



INFERIOR

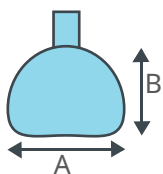

Tamaño mm.	REF.	Tamaño estándar
61x47	3050.U1	1
64x51	3050.U2	2
66x53	3050.U3	3
69x57	3050.U4	4
71x60	3050.U5	5
73x62	3050.U6	6

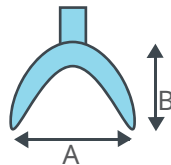

Tamaño mm.	REF.	Tamaño estándar
55x47	3050.L1	1
60x49	3050.L2	2
72x54	3050.L3	3
75x57	3050.L4	4
76x59	3050.L5	5
78x61	3050.L6	6

PRÓTESIS

CUBETAS

Nº1 BORDES DERECHOS DELGADOS

SUPERIOR

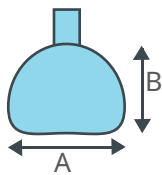

Tamaño mm.	REF.	Tamaño estándar
61x47	3040.U1	1
64x51	3040.U2	2
66x53	3040.U3	3
69x57	3040.U4	4
71x60	3040.U5	5
73x62	3040.U6	6

INFERIOR

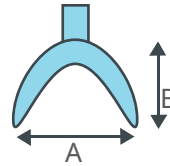

Tamaño mm.	REF.	Tamaño estándar
55x47	3040.L1	1
60x49	3040.L2	2
72x54	3040.L3	3
75x57	3040.L4	4
76x59	3040.L5	5
78x61	3040.L6	6

MEDIAS CUBETAS

DERECHA

IZQUIERDA

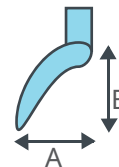

	Tamaño mm.	REF.
IZQUIERDO	30x49	3040.L2S
	37x57	3040.L4S
	39x61	3040.L6S
DERECHO	30x49	3040.L2D
	37x57	3040.L4D
	39x61	3040.L6D

Personalice sus cubetas gratuitamente a partir de 20 piezas.

PRÓTESIS

MOLDES, EMISOR DE CORONAS / INSTRUMENTOS PARA PRÓTESIS

CUCHILLO PARA ELIMINAR EL EXCESO DE SILICONA

Anillo afilado

3 cuchillas laterales afiladas.



XL Style

REF. 453.00XL

Design

REF. 453.00D

COLOCACIÓN DE CORONAS



REF. 3087.00

ELIMINACIÓN DE CORONAS



REF. 105.00

PINZA PARA PAPEL DE ARTICULAR



REF. 433.00

PINZA PARA NERVIOS



14 cm

REF. 751.00

FURRER



14 cm

REF. 897.00



INSTRUMENTOS PARA PERIODONCIA

Limpiadores de Sarro.....	42-44
Sondas graduadas.....	45
Escalpelos e Instrumentos Aflados.....	46-47
Pinzas	48
Elevadores	49
Portaagujas	50

PERIODONCIA

CURETAS

Sólo disponibles con el mango **XL Style**.



XL Style

GRACEY

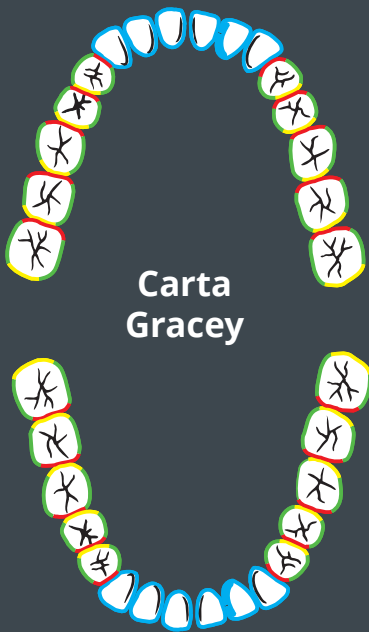
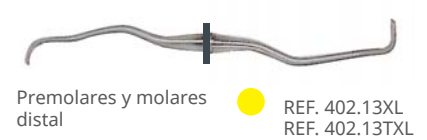
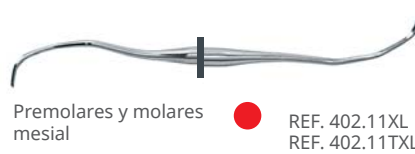
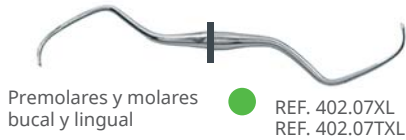
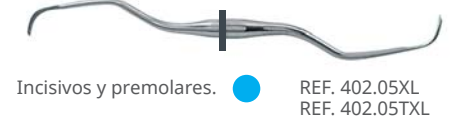

REVESTIMIENTO DE NITRURO DE ZIRCONIO (ZRN)
(REF. terminadas por TXL)

**Material biocompatible.
Mantiene el filo durante mucho tiempo.**



CRANE KAPLAN

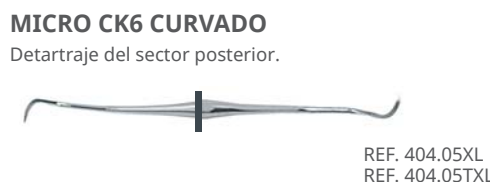
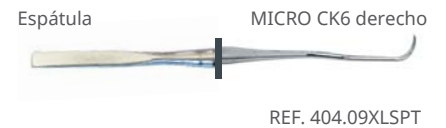
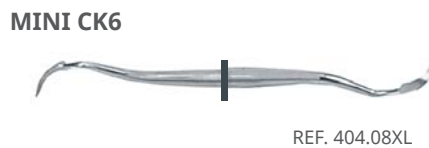

PERIODONCIA

LIMPIADORES DE SARRO

Sólo disponibles con el mango **XL Style**.



XL Style

GOLDMAN-FOX



REF. 401.02XL



REF. 401.03XL



REF. 401.04XL



REF. 406.01XL



REF. 406.21XL



MAC CALL



REF. 403.13XL



REF. 403.17XL



REF. 420.07XL

ORBAN

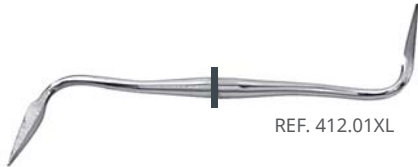

REF. 412.01XL

BUCK

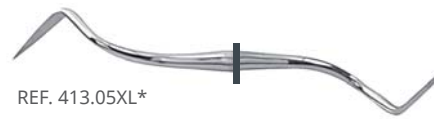

REF. 413.05XL*

WEDELSTAEDT (W.E.D.)



REF. 115.02XL



REF. 115.03XL



REF. 115.09XL



REF. 115.10XL



REF. 115.48XL



*Fabricado bajo pedido.

PERIODONCIA

LIMPIADORES DE SARRO

Sólo disponibles
con el
mango **Design**.



Design

ZERFING



REF. 409.02D



REF. 409.03D

KIRKLAND



REF. 414.13D*



REF. 414.14D*

TOWNER



REF. 410.15D

I.D.I.



REF. 410.16D*

I.N.H.



REF. 185.03D

DEVIN



REF. 185.04D

JAQUETTE



REF. 184.01D



REF. 184.02D*



REF. 184.03D*

I.N.A.



REF. 183.01D



REF. 183.02D



REF. 183.03D



REF. 183.04D



REF. 183.06D



REF. 183.07D



REF. 183.32D



REF. 183.33D



REF. 183.34D

DARBY PERRY



REF. 184.04D*



REF. 184.05D*



REF. 184.06D*



REF. 184.11D*

THORPE



REF. 185.22D

PERIODONCIA

SONDAS GRADUADAS

SONDAS GRADUADAS

SONDA CURVADA



Marcado láser 3/6/9 mm

REF. 418.02XL

ELIJA SU MANGO

Los instrumentos están disponibles opcionalmente con el mango **XL Style** o el mango **Design**.



XL Style REF. terminandas en XL.



Design REF. terminandas en D.

PUNTA CÓNICA



Marcado láser
3/6/9/11/13/16 mm
REF. 418.00XL
REF. 418.00D

Marcado láser
3/6/9 mm
REF. 418.01XL
REF. 418.01D

PUNTA EN FORMA DE BOLA



REF. 271.00XL
REF. 271.00D

PUNTA PLANA



REF. 419.00XL
REF. 419.00D

PUNTA PERIO GRADUADA



Marcado láser
5/10/15/20 mm
REF. 418.03D

PERIODONCIA

ESCALPELOS

ESCALPELOS

BARD PARKER: SISTEMA DE ESCALPELO ¡SIN RIESGOS!

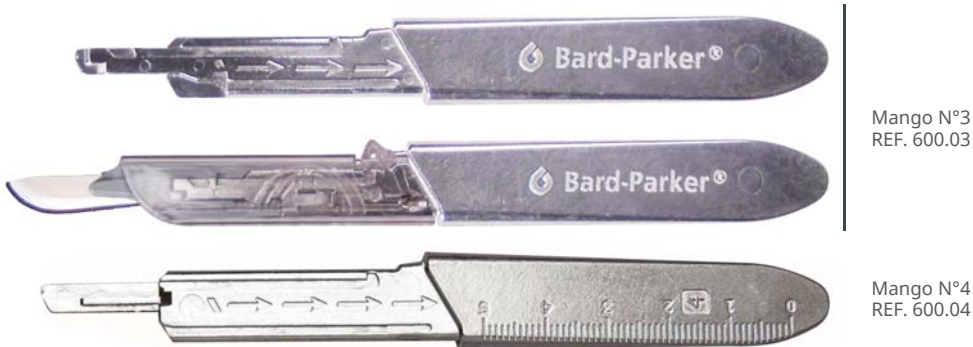

Mango de bisturí para cuchilla estéril muy fina desechable, con bloqueo de seguridad de plástico. El protector de plástico cubre la cuchilla al colocarla y retirarla.

CUCHILLAS ESTÉRILES X1



Para mango N°3

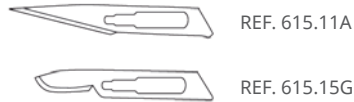

Para mango N°4

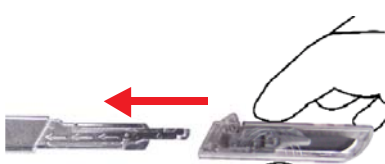

1. Coloque la cuchilla enfundada en el mango, con seguridad.



2. Presione para desbloquear la funda...

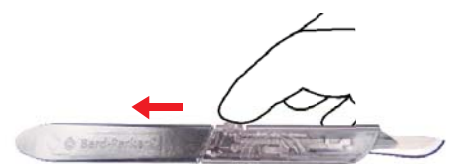

3. ...y empuje para liberar la cuchilla.

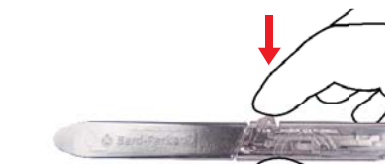

4. Presione para desbloquear la funda...



5. ...y tire para cubrir la cuchilla.



6. Tire para quitar la cuchilla.

PERIODONCIA

ESCALPELOS E INSTRUMENTOS AFILADOS

ESCALPELOS

Mango **XL Style** para un mejor agarre y más fácil de girar.



REF. 610.00XL

Mango estándar económico.



REF. 601.03

Cuchillas vendidas por separado.



Cuchillas estériles N°11
x100
REF. 615.11



Cuchillas estériles N°15
x100
REF. 615.15

INSTRUMENTOS AFILADOS



KIRKLAND
REF. 411.15XL



KIRKLAND
REF. 414.16XL



KIRKLAND
REF. 414.15XL

PERIODONCIA

PINZAS

PINZAS DE SUTURA



Suturas, con ojales de 15 cm
REF. 428.00



Suturas, con ojales abiertos de 15 cm
REF. 429.00



sutura **CORN** de 15 cm
REF. 432.00

PINZAS PARA MARCAR GOLDMAN-FOX



Marcado derecho 15 cm
REF. 417.01



Marcado izquierdo 15 cm
REF. 417.02

PERIODONCIA

ELEVADORES

ELEVADORES DE MOLT

ELIJA SU MANGO

Los instrumentos están disponibles opcionalmente con el mango **XL Style** o el mango **Design**.



XL Style REF. terminandas en XL.



Design REF. terminandas en D.

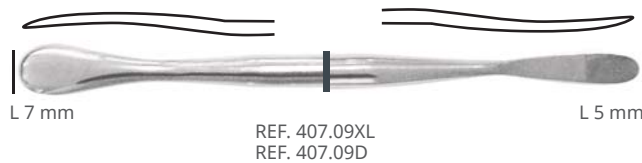
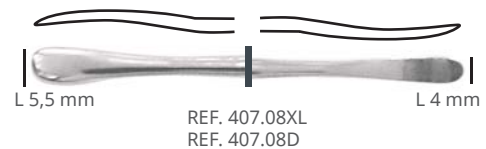
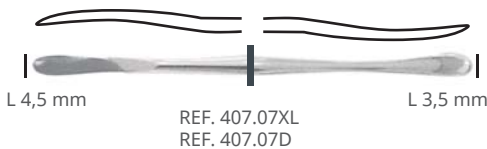

ELEVADORES DR ROOS

3 EN 1
¡TODAS LAS VENTAJAS DE UN ELEVADOR, UN RETRACTOR Y LA VISIÓN DE UN EXCELENTE ESPEJO!



INDICACIONES

- Retirar los tejidos blandos.
- Retraer y extender con soporte óseo.
- Gracias al espejo integrado, permite un control visual preciso del acto quirúrgico durante su realización.

PERIODONCIA

PORTAAGUJAS

MATHIEU



REF. 743.00TC
REF. 743.00

¡LA AGUJA NO SE MUEVE EN LAS MANDÍBULAS!

TC : Mandíbulas en carburo de tungsteno:
Resistencia al desgaste.



REF. 744.00TC
REF. 744.00

CASTROVIEJO

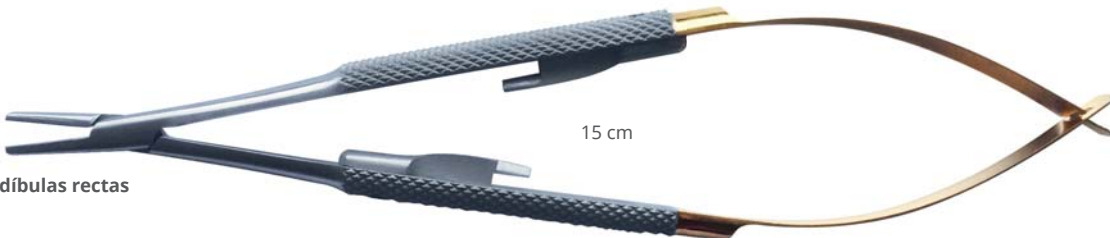

Mandíbulas rectas

REF. 747.01TC

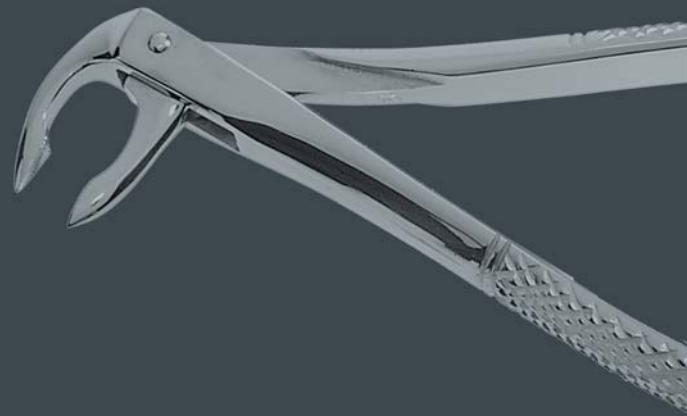

INSTRUMENTOS PARA EXTRACCIÓN

Sindesmotomos	52
Elevadores	54
Elevadores Vignal.....	56
Fórceps de Avulsión Dental.....	57
Curetas.....	60

EXTRACCIÓN

SINDESMOTOMOS

SINDESMOTOMOS FIJOS DU DR BERNARD



<p>CUCHILLA DR BERNARD ESTÁNDAR</p>										
REF. 237.00	REF. 237.01	REF. 237.02	REF. 237.03	REF. 237.04	REF. 237.05	REF. 237.06	REF. 237.07	REF. 237.08	REF. 237.09	REF. 237.11
<p>CUCHILLA DR BERNARD FINA</p>										
	REF. 237.21	REF. 237.22	REF. 237.23	REF. 237.24	REF. 237.25	REF. 237.26	REF. 237.27	REF. 237.28	REF. 237.29	

SINDESMOTOMOS CHOMPRET

Hoja de hoz: Permite cortar sin traumatismo los ligamentos periodontales pero también se utiliza para realizar separaciones o extracciones de raíces.



REF. 264.03 (mango macizo)
REF. 265.03 (mango hueco)



Mango macizo

Hoja recta: Se utiliza al principio de la extracción para eliminar la encía.



REF. 264.01 (mango liso)
REF. 265.01 (mango hueco)

REF. 264.02 (mango liso)
REF. 265.02 (mango hueco)

Para las muelas del juicio



REF. 264.04 (mango liso)
REF. 265.04 (mango hueco)

SINDESMOTOMOS PERIOTOMOS

Cuchilla fina y flexible para separar el ligamento periodontal antes de la extracción.



REF. 264.11



REF. 264.10

Curvado para acceso posterior, cuchilla: ancho 1mm.



REF. 264.12

SINDESMOTOMOS WARWICK-JAMES



REF. 158.01

Mango hueco ligero



REF. 158.02



REF. 158.03

EXTRACCIÓN

SINDESMOTOMOS

SINDESMOTOMOS DR BERNARD



Mango del Dr. BERNARD para cuchillas extraíbles.

REF. 236.00

CUCHILLAS DESMONTABLES

<p style="text-align: center;">CUCHILLA DR BERNARD ESTÁNDAR</p>										
REF. 235.00	REF. 235.01	REF. 235.02	REF. 235.03	REF. 235.04	REF. 235.05	REF. 235.06	REF. 235.07	REF. 235.08	REF. 235.09	REF. 235.11
<p style="text-align: center;">CUCHILLA DR BERNARD FINA</p>										
	REF. 235.21	REF. 235.22	REF. 235.23	REF. 235.24	REF. 235.25	REF. 235.26	REF. 235.27	REF. 235.28	REF. 235.29	

KITS DE SINDESMOTOMOS CUCHILLAS DESMONTABLES DR BERNARD



**2 mangos 236.00,
11 cuchillas estándar,
Caja de aluminio.**

REF. 241.00

**2 mangos 236.00,
9 cuchillas finas,
Caja de aluminio.**

REF. 241.01

**2 mangos 236.00,
9 cuchillas finas,
11 lames standards,
Caja de aluminio.**

REF. 241.02



**Caja de aluminio vacía.
7,5x17,5x3 cm**

REF. 242.00

EXTRACCIÓN

ELEVADORES

ELEVADORES DE CUCHILLAS DESMONTABLES

Kit 1 mango
+ 5 cuchillas
REF. 159.K



Mango
REF. 159.M

Sistema de bloqueo del
sindesmotomo BERNARD

CUCHILLAS
DESMONTABLES



REF. 159.54F



REF. 159.55F



REF. 159.56F



REF. 159.60F



REF. 159.52F

ELEVADORES LUXADORES



REF. 159.3C



REF. 159.3D



REF. 159.5C



REF. 159.5D

ELEVADOR BARRY



REF. 157.02

REF. 157.03

REF. 157.04

REF. 157.05

REF. 157.06

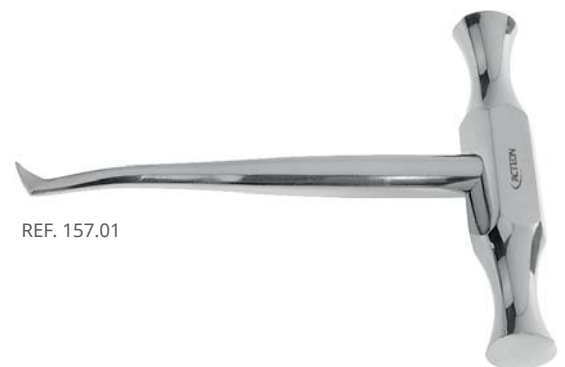

REF. 157.01

ELEVADORES KOPP

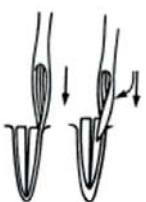

SENTIDO IZQUIERDO
REF. 156.40



SENTIDO DERECHO
REF. 156.41

Los ascensores **KOPP** tienen un filo helicoidal que sigue la forma de la raíz y corta el periodonto. El corte se produce naturalmente con un movimiento apical.

Ideal para rotar alrededor de una raíz.

EXTRACCIÓN

ELEVADORES

ELIJA SU MANGO



MANGO LIGERO ESTÁNDAR (1)



MANGO LIGERO ERGONÓMICO (2)

ELEVADORES

	2,5 mm REF. 156.50 (1) REF. 159.50 (2)		2,5 mm REF. 156.51 (1) REF. 159.51 (2)		3 mm REF. 156.52 (1) REF. 159.52 (2)		BEIN 5 mm REF. 156.53 (1) REF. 159.53 (2)
	5 mm REF. 156.54 (1) REF. 159.54 (2)		4 mm REF. 156.55 (1) REF. 159.55 (2)		4 mm REF. 156.56 (1) REF. 159.56 (2)		5 mm REF. 156.57 (1) REF. 159.57 (2)
	4 mm REF. 156.58 (1) REF. 159.58 (2)		3 mm REF. 156.59 (1) REF. 159.59 (2)		3 mm REF. 156.60 (1) REF. 159.60 (2)		3,5 mm REF. 156.61 (1) REF. 159.61 (2)
	3 mm REF. 156.62 (1) REF. 159.62 (2)		WHITE APICAL 3 mm REF. 156.63 (1) REF. 159.63 (2)		WHITE APICAL 3 mm REF. 156.64 (1) REF. 159.64 (2)		WHITE APICAL 3 mm REF. 156.65 (1) REF. 159.65 (2)
	BEIN 3 mm REF. 156.66 (1) REF. 159.66 (2)		BEIN 4 mm REF. 156.67 (1) REF. 159.67 (2)		BEIN 4 mm REF. 156.68 (1) REF. 159.68 (2)		ROY REF. 156.69 (1) REF. 159.69 (2)
	CRYER REF. 156.70 (1) REF. 159.70 (2)		CRYER REF. 156.71 (1) REF. 159.71 (2)		SELDIN REF. 156.72 (1) REF. 159.72 (2)		SELDIN REF. 156.73 (1) REF. 159.73 (2)
	SELDIN 6 mm REF. 156.74 (1) REF. 159.74 (2)		SELDIN 4 mm REF. 156.75 (1) REF. 159.75 (2)		HEIDBRINK apex 2 mm REF. 156.76 (1) REF. 159.76 (2)		HEIDBRINK apex 2 mm REF. 156.77 (1) REF. 159.77 (2)
	HEIDBRINK apex 2 mm REF. 156.78 (1) REF. 159.78 (2)		REF. 159.79 (2)				

COUPLAND



REF. 156.84 (1)

REF. 156.86 (1)

EXTRACCIÓN

ELEVADORES VIGNAL

BAYONETAS VIGNAL



REF. 149.01

Mango estándar



REF. 149.02

REF. 149.03

REF. 149.04

REF. 149.05

REF. 149.06

VIGNAL



3,5 mm REF. 149.07



3 mm REF. 149.08



3 mm REF. 149.09



2,5 mm REF. 149.10



3 mm REF. 149.11



3 mm REF. 149.12



3 mm REF. 149.13



4,5 mm REF. 149.14



4 mm REF. 149.15



3 mm REF. 149.16



2 mm REF. 149.17



2 mm REF. 149.18



3 mm REF. 149.19



4 mm REF. 149.20



5 mm REF. 149.21



3 mm REF. 149.22



3 mm REF. 149.23



2,5 mm REF. 149.24



3,5 mm REF. 149.25



3,5 mm REF. 149.26



3 mm REF. 149.32



3 mm REF. 149.33



3 mm REF. 149.34

EXTRACCIÓN

FÓRCEPS DE AVULSIÓN DENTAL

FÓRCEPS DE AVULSIÓN DENTAL (NIÑO)



Incisivos superiores,
CON RESORTE (1)
REF. 295.01



Incisivos superiores,
SIN RESORTE (2)
REF. 296.01



Premolares
superiores
REF. 295.02 (1)
REF. 296.02 (2)



Raíces
superiores
REF. 295.03 (1)
REF. 296.03 (2)



Molares
superiores
REF. 295.04 (1)
REF. 296.04 (2)



Incisivos
inferiores
REF. 295.05 (1)
REF. 296.05 (2)



Molares
inferiores
REF. 295.06 (1)
REF. 296.06 (2)



Raíces
inferiores
REF. 295.07 (2)
REF. 296.07 (2)

FÓRCEPS ESTÁNDAR (NIÑO)



Premolares inferiores
REF. 291.13



Molares
inferiores
REF. 291.22

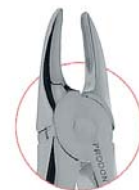

Raíces
superiores
REF. 291.29



Raíces
inferiores
REF. 291.33



Incisivos
superiores
REF. 291.37



Incisivos
y caninos
inferiores
REF. 291.38



Molares
superiores
REF. 291.39

EXTRACCIÓN

FÓRCEPS DE AVULSIÓN DENTAL

FÓRCEPS DE AVULSIÓN DENTAL (ADULTO)

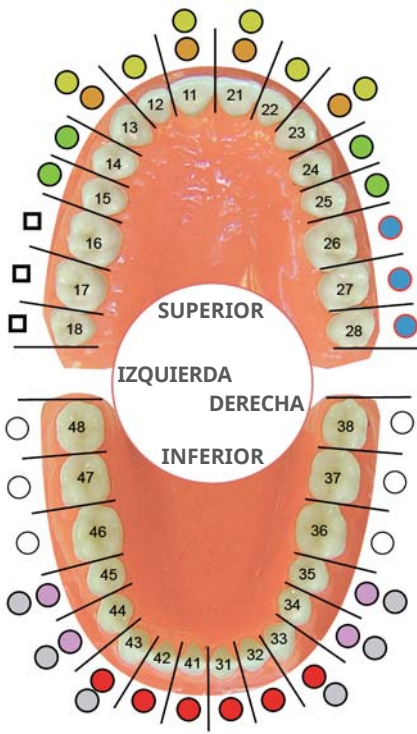

	Premolares superiores	Brillante REF. 290.07 Satinado REF. 1290.07
	Premolares inferiores	Brillante REF. 290.08 Satinado REF. 1290.08
	Caninos y premolares inferiores	Brillante REF. 290.13 Satinado REF. 1290.13
	Molares superiores derechos	Brillante REF. 290.17 Satinado REF. 1290.17
	Molares superiores izquierdos	Brillante REF. 290.18 Satinado REF. 1290.18

	Incisivos centrales y caninos superiores	Brillante REF. 290.01 Satinado REF. 1290.01
	Incisivos y caninos superiores	Brillante REF. 290.02 Satinado REF. 1290.02
	Incisivos y caninos inferiores	Brillante REF. 290.04 Satinado REF. 1290.04

	Molares inferiores	Brillante REF. 290.21 Satinado REF. 1290.21
	Molares inferiores	Brillante REF. 290.22 Satinado REF. 1290.22
	Molares inferiores	Brillante REF. 290.73 Satinado REF. 1290.73
	Caninos y premolares inferiores	Brillante REF. 290.75 Satinado REF. 1290.75

EXTRACCIÓN

FÓRCEPS DE AVULSIÓN DENTAL

FÓRCEPS DE AVULSIÓN DENTAL (ADULTO)

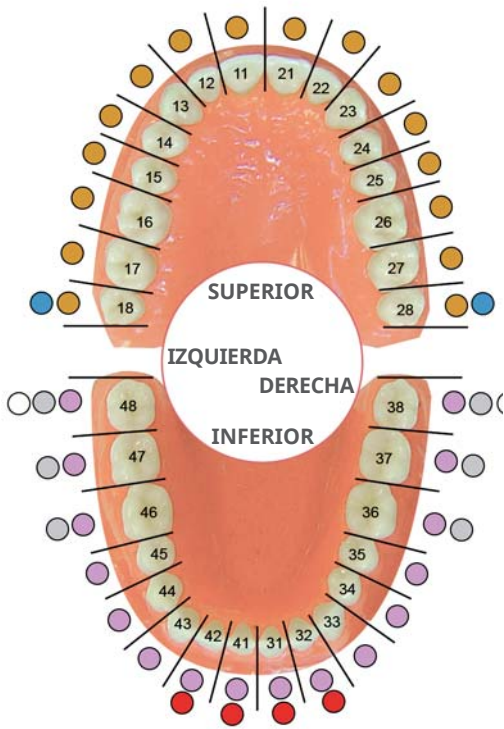

	Raíces inferiores	Brillante REF. 290.33 Satinado REF. 1290.33
	Raíces superiores	Brillante REF. 290.51 Satinado REF. 1290.51
	Muelas del juicio inferiores	Brillante REF. 290.79 Satinado REF. 1290.79
	Raíces superiores	Brillante REF. 291.51 Satinado REF. 1291.51
	Raíces superiores, mandíbula extrafina	Brillante REF. 291.60 Satinado REF. 1291.60

	Raíces superiores, corto, mandíbula extrafina	Brillante REF. 291.61 Satinado REF. 1291.61
	Raíces superiores, mandíbula extrafina	Brillante REF. 291.62 Satinado REF. 1291.62
	Muelas del juicio superiores, 2 lados	Brillante REF. 291.67 Satinado REF. 1291.67
	Raíces e incisivos inferiores	Brillante REF. 291.74 Satinado REF. 1291.74
	Molares inferiores deteriorados o con la corona dañada	Brillante REF. 291.86 Satinado REF. 1291.86

EXTRACCIÓN

CURETAS

ELIJA SU MANGO

Los instrumentos están disponibles opcionalmente con el mango **XL Style** o el mango **Design**.



HEMINGWAY



LUCAS



CURETAS CHOMPRET

CHOMPRET

Después de la extracción, el curetage alveolar permite retirar los tejidos infectados y favorece la coagulación y la osteogénesis.



LUER FRIEDMANN PLIER



CURETAS DE GRANULACIÓN

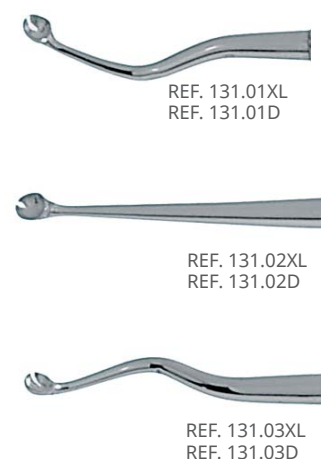

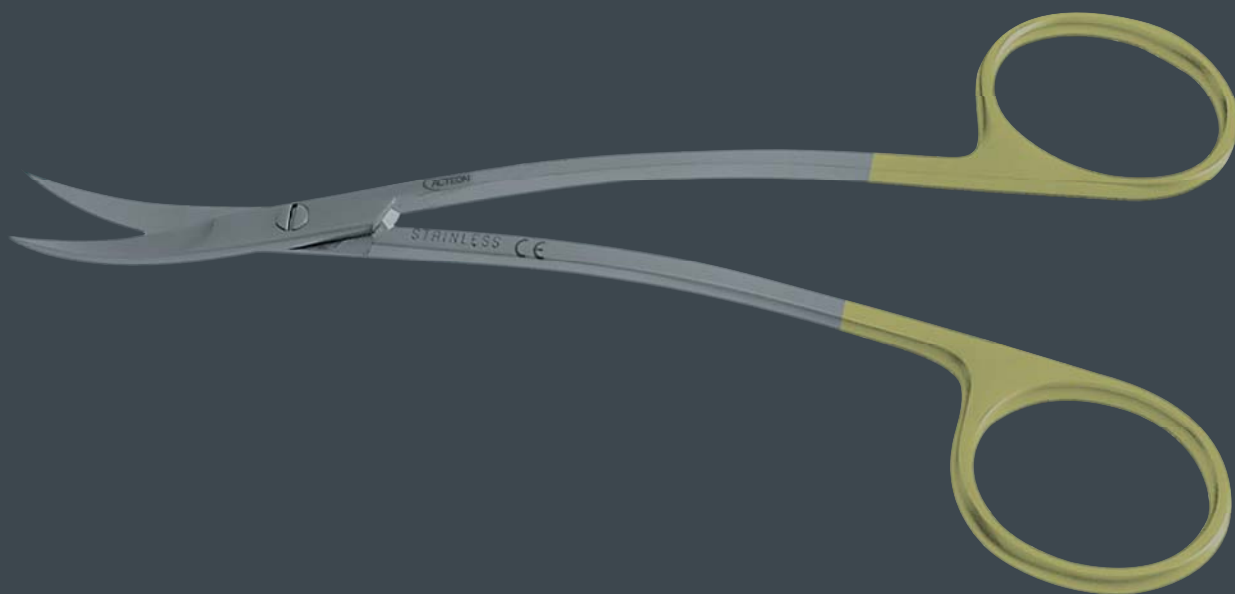

INSTRUMENTOS PARA CIRUGÍA

Tijeras	62
Pinzas	64
Fórceps hemostáticos	65
Portaagujas	66
Escalpelos	67
Bandejas Endocirugía	68

CIRUGÍA

TIJERAS

**CARBURO DE TUGSTENO (TC) :
RESISTENCIA AL DESGASTE.
CALIDAD DE CORTE PRESERVADA.**

¡ EL HILO NO SE DESLIZA !

◄ Mandíbulas rectas

◄ Mandíbulas curvadas



10,5 cm
REF. 621.00TC.
REF. 621.00



10,5 cm
REF. 622.00TC.
REF. 622.00



9 cm
REF. 623.00TC
REF. 623.00



12 cm
REF. 627.00TC
REF. 627.00



9 cm
REF. 624.00



11 cm
REF. 625.00

GOLDMAN FOX



13 cm
REF. 629.00



13 cm
REF. 630.00



11 cm
REF. 620.01TC.
REF. 620.01

LAGRANGE

- Forma anatómica.
- Expande la arcada.
- Evita pinchar al paciente.

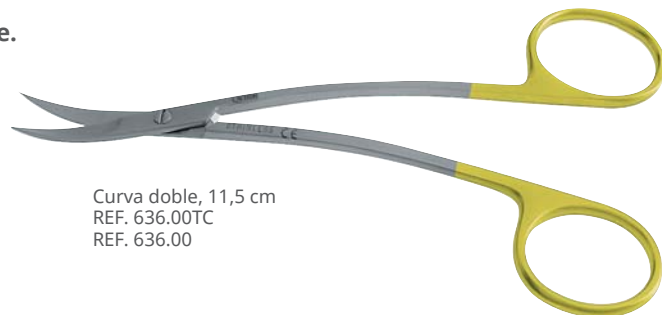

Curva doble, 11,5 cm
REF. 636.00TC
REF. 636.00

JOSEPH



14 cm
REF. 628.00

DEAN



17 cm
REF. 632.00

SPENCER



14 cm
REF. 633.00

CIRUGÍA

TIJERAS

METZENBAUM

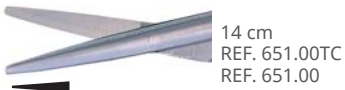

14 cm
REF. 651.00TC
REF. 651.00



14 cm
REF. 652.00TC
REF. 652.00

CASTROVIEJO



12 cm
REF. 647.01TC



12 cm
REF. 647.02TC

NOYES



12 cm
REF. 635.00



12 cm
REF. 635.01

CISEAUX



MAYO
14 cm
REF. 653.00



MAYO
14 cm
REF. 653.01



13 cm
REF. 654.00



13 cm
REF. 656.00



13 cm
REF. 655.01TC
REF. 655.00



13 cm
REF. 654.01TC

CIRUGÍA

PINZAS

PRÉCELLES À TISSUS

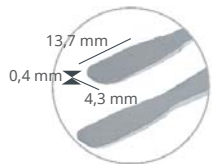

Mandíbulas planas o pinza de tejido de injerto de membrana, 12 cm
REF. 222.13.



ADSON 12,5 cm
REF. 222.10

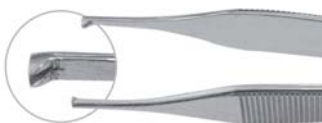

ADSON 12 cm
REF. 222.11



ADSON 12,5 cm
REF. 222.12



13 cm
REF. 222.04

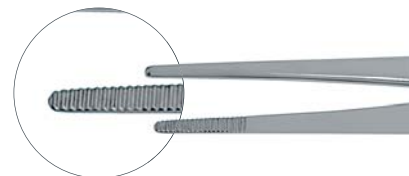

14 cm
REF. 222.06

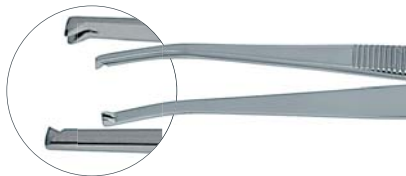

13 cm
REF. 222.05

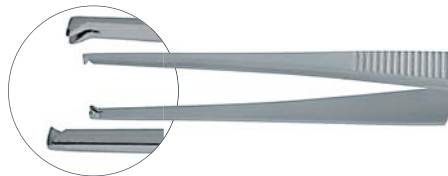

14 cm
REF. 222.07

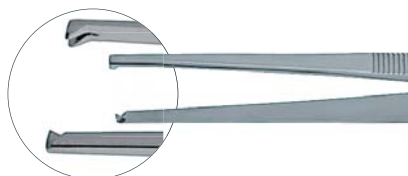

18 cm
REF. 222.08

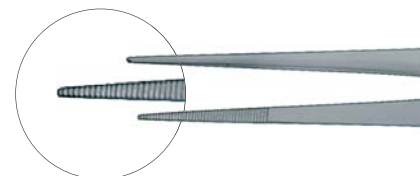

18 cm
REF. 222.09

PINZAS DE SUTURA Y DE MARCAR



Pinza para marcar **GOLDMAN FOX**, derecha, 15 cm
REF. 417.01



Pinza para marcar **GOLDMAN FOX**, izquierda, 15 cm
REF. 417.02



Pinza de sutura con ojales, 15 cm
REF. 428.00



Pinza de sutura con ojales abiertos, 15 cm
REF. 429.00



Pinza de sutura **CORN**, 15 cm
REF. 432.00

CIRUGÍA

FÓRCEPS HEMOSTÁTICOS

MOSQUITO



HALSTEAD-MOSQUITO



CRILLE



PEAN



KOCHER

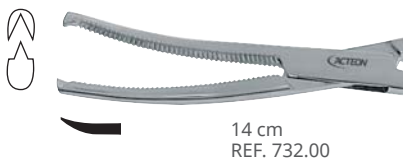

BACKHAUS

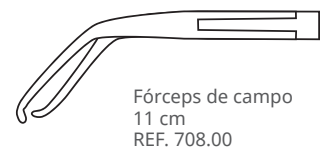

FÓRCEPS LUER FRIEDMANN



▴ Mandíbulas rectas ▾ Mandíbulas curvadas

CIRUGÍA

PORTAAGUJAS

**CARBURO DE TUNGSTENO (TC):
EFECTO GRIP,
RESISTENCIA AL DESGASTE.**

¡ LA AGUJA NO SE MUEVE EN LA
MANDÍBULA !

MATHIEU



REF. 743.00TC
REF. 743.00



REF. 744.00TC
REF. 744.00

CASTROVIEJO

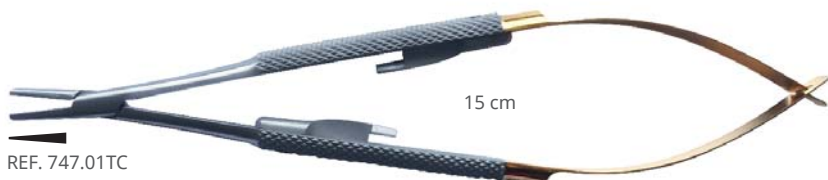

REF. 747.01TC



REF. 747.11
REF. 747.11TC



REF. 747.12TC
REF. 747.12

CRILE WOOD



REF. 748.00TC

ESCALPELOS

BARD PARKER : ¡ SISTEMA DE ESCALPELO SIN RIESGOS !



Mango de bisturí para hoja estéril muy fina desechable, con bloqueo de seguridad de plástico. El protector de plástico cubre la hoja al colocarla y retirarla.

CUCHILLAS ESTÉRILES X1



Para mango N°3



REF. 615.11A



REF. 615.15G

Para mango N°4



REF. 615.23

Mango **XL Style** para un mejor agarre y más fácil de girar.



REF. 610.00XL

Mango estándar económico.



REF. 601.03

Cuchillas vendidas por separado.



Cuchillas estériles N°11
x100
REF. 615.11



Cuchillas estériles N°15
x100
REF. 615.15

CIRUGÍA

BANDEJAS ENDOCIRUGÍA

ENDOSURGERY



Destinadas a cirugías apicales con visión indirecta a través de ayudas ópticas. La ergonomía y el tamaño de los instrumentos se han adaptado para cumplir con los procedimientos.

El objetivo es perfeccionar la eliminación de tejidos blandos a pesar de los requerimientos de la raíz y facilitar la obturación retro.

ENDOSURGERY

ESSENTIAL

11 INSTRUMENTOS

REF. 230XL

233.20	Bandeja de cirugía 285x92x37mm + 2 clips.
610.01XL	Minibisturí.
407.16XL	Retractor de mejilla.
263.18XL	Soda de doble cara Explorer n ° 17.
135.87XL	Cureta ósea Lucas.
412.07XL	Cureta para huesos y tejidos n ° 1.
412.13XL	Cureta para huesos y tejidos n ° 2.
MP3303PH	Microespejo Pure Reflect® Ø 3 mm.
MP3306RPH	Microespejo rectangular Pure Reflect® 7x2 mm.
210.02XL	Mango XL doble para microespejos.
193.10XL	Espátula para material de obturación.
230.00XL	Cond. doble plugger 6mm / 4mm.
230.01XL	Cond. / bruñidor plugger 3mm.
164.19XL	Miniexcavador.

ENDOSURGERY

INTEGRAL

17 INSTRUMENTOS

REF. 231XL

233.20	Bandeja de cirugía 285x92x37mm +2 clips.
610.01XL	Minibisturí.
407.16XL	Retractor de mejilla.
263.18XL	Soda de doble cara Explorer n ° 17.
135.87XL	Cureta ósea Lucas.
412.07XL	Cureta para huesos y tejidos n ° 1.
412.13XL	Cureta para huesos y tejidos n ° 2.
MP3303PH	Microespejo Pure Reflect® Ø 3 mm.
MP3306RPH	Microespejo rectangular Pure Reflect® 7x2 mm.
210.02XL	Mango XL doble para microespejos.
193.10XL	Espátula para material de obturación.
230.00XL	Cond. doble plugger 6mm / 4mm.
230.01XL	Cond. / bruñidor plugger 3mm.
164.19XL	Miniexcavador.
610.00XL	Bisturí.
210.36XL	Mango con espejo XL + Pure Reflect® n° 4.
747.02TC	Portaagujas Castroviejo, mandíbulas curvadas, de carburo de tungsteno.
636.00TC	Tijeras Lagrange, curvadas de carburo de tungsteno.
151.K	Kit retractor 3 cuchillas.
222.02	Pinzas Perry.

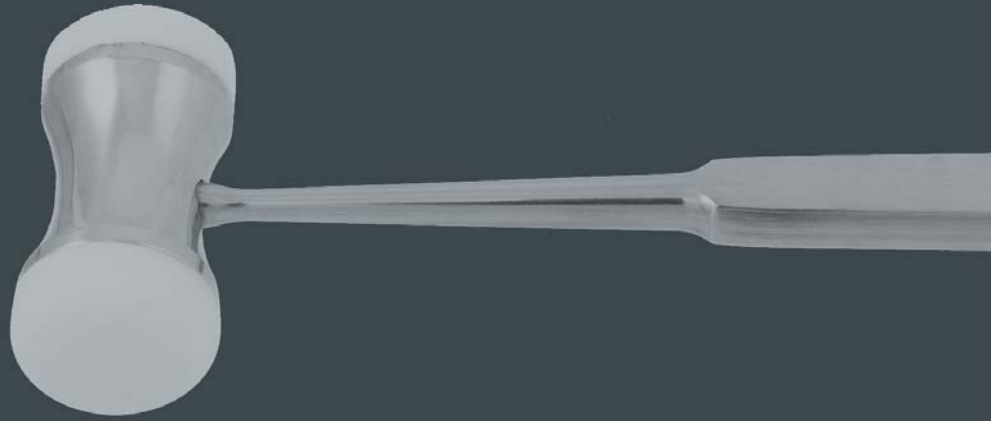

INSTRUMENTOS PARA IMPLANTOLOGÍA

Cinceles de Hueso	70
Ralladores Óseos y Divisores de Hueso.....	71
Osteotomos.....	72
Accesorios	75
Instrumentos de Medida.....	77
Pinzas para Tejido	78
Portaagujas y Tijeras TC.....	79
Periotomo Dr. Roos y Destornillador	80
Minielevadores y Elevadores de Senos.....	81
Extractores	82

IMPLANTOLOGÍA

CINCELES DE HUESO

CINCELES DE HUESO



CINCELES DE HUESO - BISEL SIMPLE

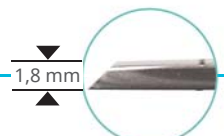

Tope



Herramienta de montaje
REF. 200.20

CINCELES DE HUESO - BISEL DOBLE

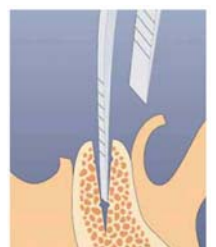
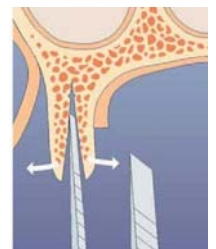
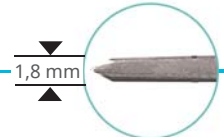

IMPLANTOLOGÍA

RALLADORES ÓSEOS Y DIVISORES DE HUESO

RALLADOR DE HUESOS



XL Style

REF. 4522.02XL



REF. 4522.03XL

DIVISOR DE HUESOS - ESQUINAS ANGULADAS



Esquinas anguladas

4 mm
REF. 200.01



L 3,5 mm

REF. 150.20

6 mm
REF. 200.02



L 5 mm

REF. 150.21

8 mm
REF. 200.03



L 7 mm

REF. 150.22

DIVISOR DE HUESOS - ESQUINAS REDONDEADAS



Esquinas redondeadas



Herramienta de montaje
REF. 200.20



Mango con asa.



L 2,3 mm

REF. 150.30



L 3 mm

REF. 150.31



L 4 mm

REF. 150.32

IMPLANTOLOGÍA

OSTEOTOMOS

OSTEOTOMOS RECTOS CONVEXOS

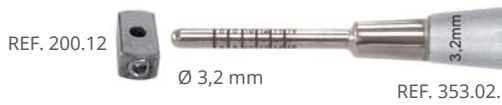

Kit de 5 osteotomos rectos convexos, (Bandeja gratis).
REF. 353.11



Herramienta de montaje.
REF. 200.20

OSTEOTOMOS RECTOS CÓNCAVOS



Kit de 5 osteotomos rectos cóncavos, (Bandeja gratis).
REF. 354.11

IMPLANTOLOGÍA

OSTEOTOMOS

OSTEOTOMOS RECTOS CÓNICOS CONVEXOS



Kit de 6 osteotomos rectos cónicos convexos, (Bandeja gratis).
REF. 355.11



Herramienta de montaje.
REF. 200.20

OSTEOTOMOS ANGULADOS CONVEXOS



Kit de 5 osteotomos angulados convexos. (Bandeja gratis).
REF. 350.11

IMPLANTOLOGÍA

OSTEOTOMOS

OSTEOTOMOS ANGULADOS CÓNCAVOS

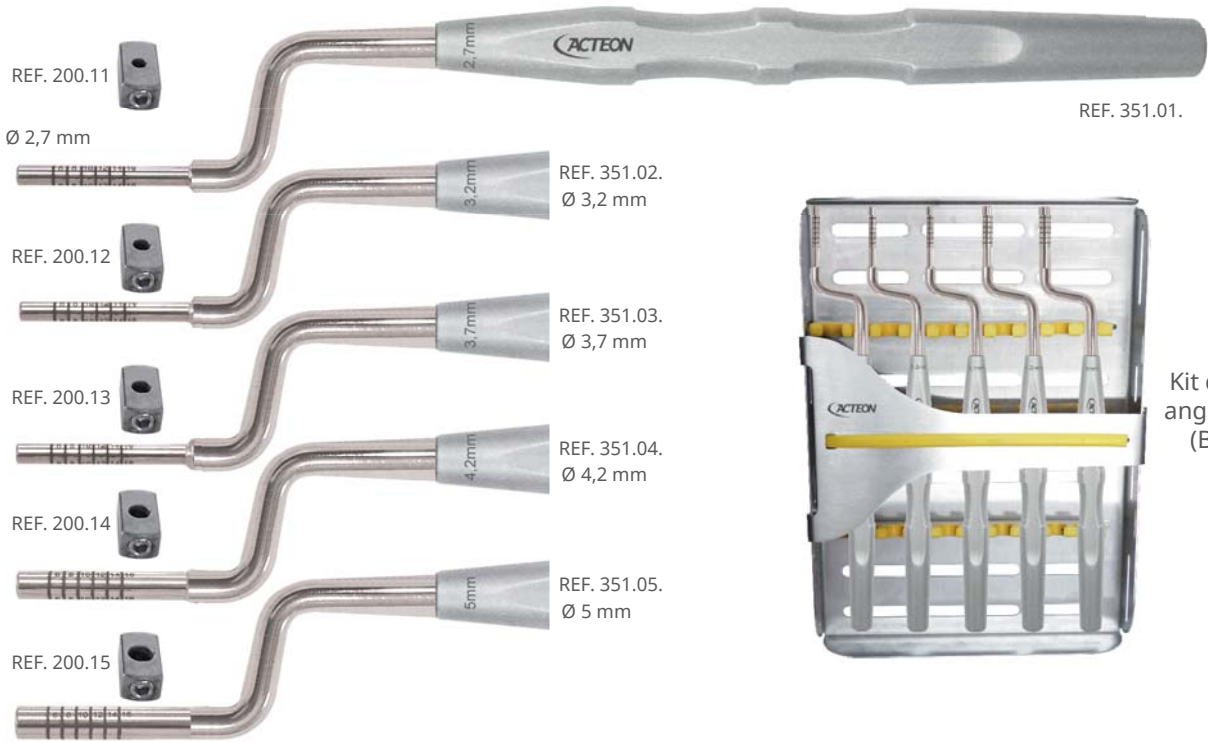

Kit de 5 osteotomos angulados cóncavos, (Bandeja gratis).
REF. 351.11

OSTEOTOMOS ANGULADOS CÓNICOS CONVEXOS

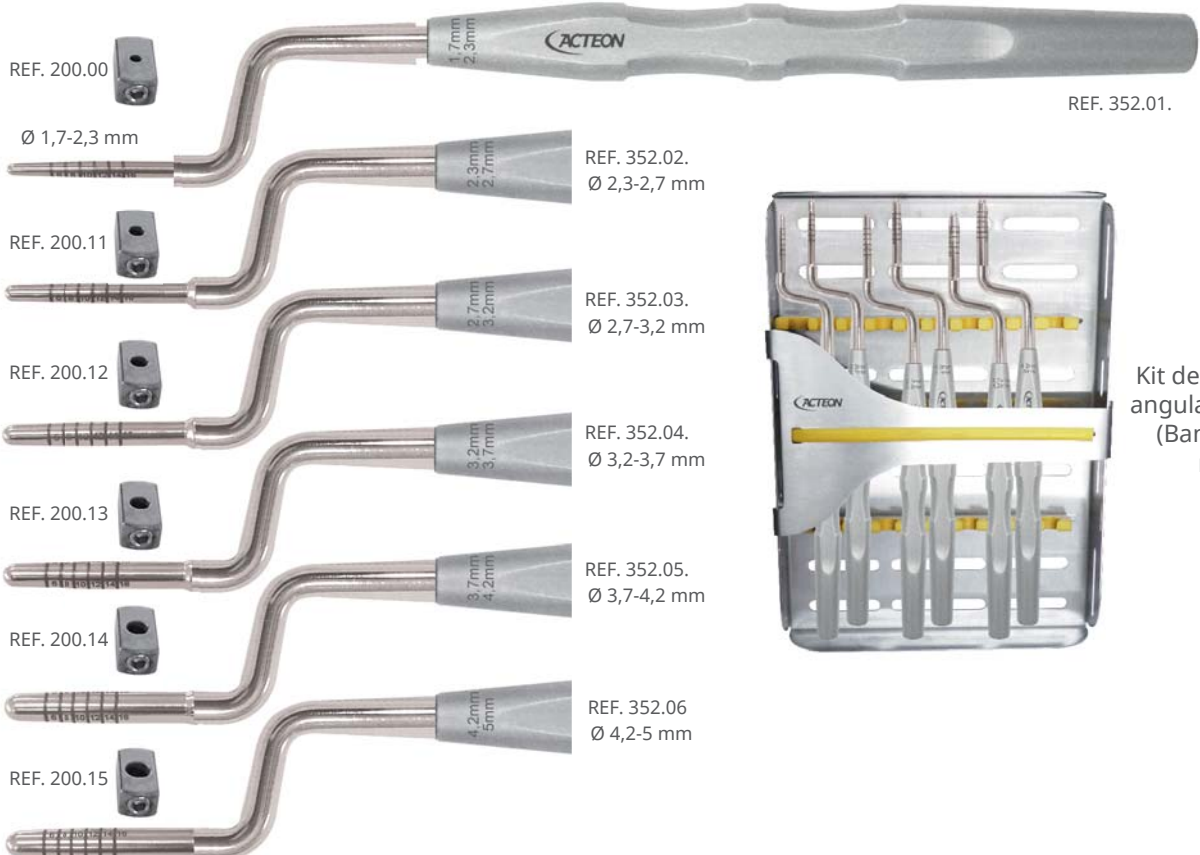

Kit de 6 osteotomos angulados convexos, (Bandeja gratis).
REF. 352.11

IMPLANTOLOGÍA

ACCESORIOS

TOPES

TOPES PARA CINCELES DE HUESO			TOPES PARA OSTEOTOMOS						HERRAMIENTA DE MONTAJE
									
4 mm REF. 200.01	6 mm REF. 200.02	8 mm REF. 200.03	Ø2,3 mm REF. 200.00	Ø2,7 mm REF. 200.11	Ø3,2 mm REF. 200.12	Ø3,7 mm REF. 200.13	Ø4,2 mm REF. 200.14	Ø5 mm REF. 200.15	REF. 200.20

MARTILLOS DE TEFLÓN



SEPARADORES

FARABOEUF (2X) REF. 151.00



SEPARADOR CONTRAANGULADO REF. 151.03



DAUTREY

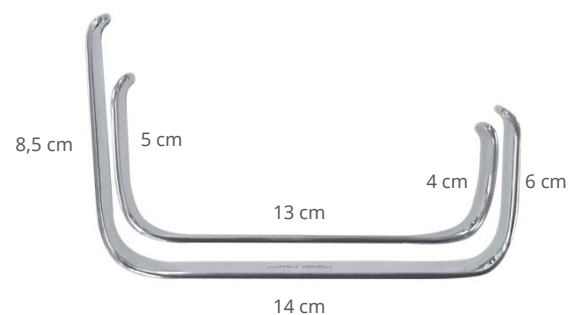

REF. 151.01

IMPLANTOLOGÍA

ACCESORIOS

RECIPIENTES DE ACERO INOXIDABLE

ESTERILIZACIÓN A 180°



Ø 40 mm
h 20 mm
0,020 L
REF. 380.00



Ø 50 mm
h 25 mm
0,035 L
REF. 380.01



Ø 60 mm
h 30 mm
0,060 L
REF. 380.02



Ø 70 mm
h 35 mm
0,085 L
REF. 380.03



Ø 80 mm
h 40 mm
0,10 L
REF. 380.04



Ø 100 mm
h 50 mm
0,25 L
REF. 380.05



Ø 120 mm
h 60 mm
0,50 L
REF. 380.06

CURETA ÓSEA



REF. 407.10XL



REF. 407.10D

DR FALCON



REF. 395.01XL



CURETA Y MEZCLADOR DE HUESO



Ø 4 cm
h 3,5 cm
28 g
REF. 390.00



REF. 395.00

IMPLANTOLOGÍA

INSTRUMENTOS DE MEDIDA

INSTRUMENTOS DE MEDIDA

COMPÁS CASTROVIEJO



Recto
8 cm REF. 3337.00



Curvado
8 cm REF. 3337.01



Redondeado REF. 3337.02
8 cm

DESTORNILLADOR



REF. 300.07

- ▶ Utilizado para enroscar o desenroscar manualmente piezas protésicas.
- ▶ Compatible con todas las puntas contraangulares.
- ▶ Tamaño largo y diámetro pequeño para permitir un posicionamiento óptimo por encima de las piezas.
- ▶ Junta universal para rotación distante.
- ▶ Muy útil en las zonas orales posteriores.
- ▶ Con anillo de cierre, se puede utilizar como destornillador recto.



DESTORNILLADOR CONTRAÁNGULO

- ▶ Muy práctico para intervenir en zonas estrechas de difícil acceso.
- ▶ Compatible con herramientas de todas las marcas.



REF. 300.10

IMPLANTOLOGÍA

PINZAS PARA TEJIDO

PINZAS PARA TEJIDO ADSON



12,5 cm
REF. 222.10



12 cm
REF. 222.11



12,5 cm
REF. 222.12

PINZAS PARA TEJIDO

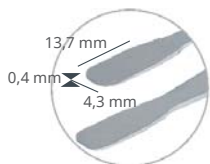

Pinza para mandíbulas planas para tejido
o injerto de membrana 12 cm.
REF. 222.13

IMPLANTOLOGÍA

PORTAAGUJAS Y TIJERAS TC

CASTROVIEJO



CARBURO DE TUNGSTENO (TC):
EFFECTO GRIP,
RESISTENCIA AL
DESGASTE.

¡ LA AGUJA NO
SE MUEVE EN LA
MANDÍBULA !

LAGRANGE



- ▶ Forma anatómica.
- ▶ Expande la arcada.
- ▶ Evita pinchar al paciente.

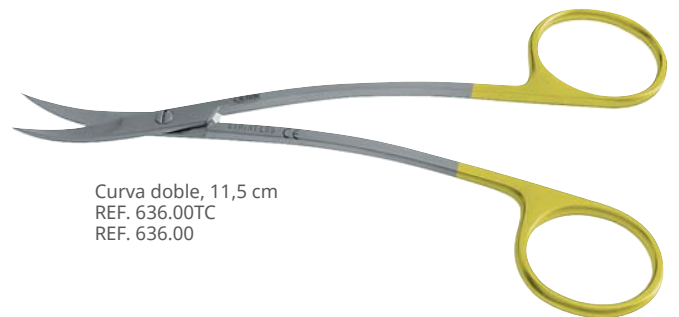

CARBURO DE TUNGSTENO (TC):
RESISTENCIA AL
DESGASTE.
NITIDEZ Y LONGEVIDAD.

METZENBAUM

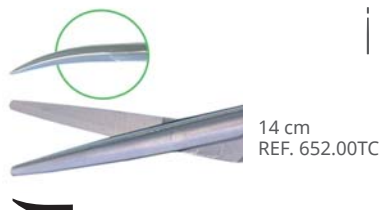
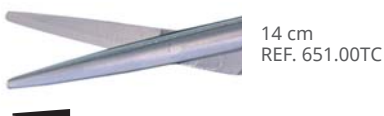

¡ EL HILO NO SE "DESLIZA" !

IMPLANTOLOGÍA

PERIOTOMO DR ROOS Y DESTORNILLADOR

PERIOTOMO DR ROOS

3 EN 1
¡ TODAS LAS VENTAJAS DE UN ELEVADOR, UN RETRACTOR Y LA VISIÓN DE UN EXCELENTE ESPEJO PURE REFLECT !



INDICACIONES

- Retirar los tejidos blandos.
- Retraer y extender con soporte óseo.
- Gracias al espejo integrado, permite un control visual preciso del acto quirúrgico durante su realización.



Ajuste del implante con control del eje durante el taladrado y atornillado.



Control de la resección apical (extirpación de un absceso en la punta de la raíz) durante cada fase: Retracción de la encía, perforación del hueso, sección de la punta de la raíz, curetaje de la cubeta ósea, preparación y cierre del conducto.



Control de la eliminación del sarro y de los defectos óseos en el espejo.

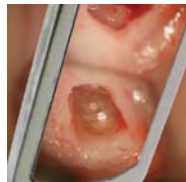

La fotografía bajo microscopio o en vista indirecta permite aumentar la profundidad de campo.

BANDEJA DE IMPLANTOLOGÍA



Contenido

Mango para espejo	210.00XL
Pinza Collège satinada	220.02S
Pinza Adson	222.12
Sonda n°6	262.06XL
Cureta CK6	404.06XL
Cureta Hemingway	135.02XL
Mango de bisturí	610.00XL
Espátula H.E.I. n°1	193.01XL
Cuchara para hueso	407.10XL
Portaagujas Castroviejo mandíbulas rectas	747.01TC
Tijeras Joseph	628.00
Retractor contraángulado	151.03
Elevador luxador	159.79

KIT XL REF. 360XL

IMPLANTOLOGÍA

MINIELEVADORES Y ELEVADORES DE SENOS

ELIJA SU MANGO

Los instrumentos están disponibles opcionalmente con el mango **XL Style** o el mango **Design**.



XL Style REF. terminandas en XL.



Design REF. terminandas en D.

MINIELEVADORES PAPILLES



MOLT

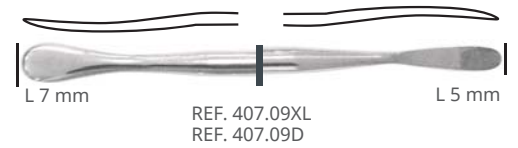
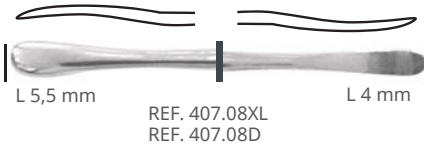
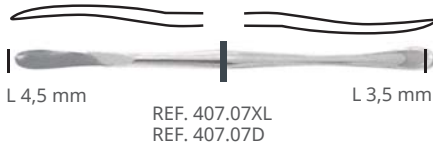

BENQUE



GOLDMAN-FOX



PRITCHARD



HOURIGAN



MINIELEVADOR DE SENO DR FALCON



ELEVADORES DE SENO

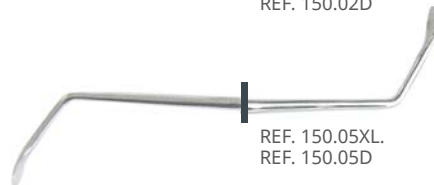
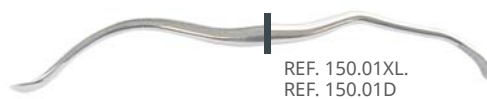

SET DE 6 ELEVADORES DE SENO

REF. 150.11XL
REF. 150.11D

IMPLANTOLOGÍA

EXTRACTORES

EXTRACTORES DE IMPLANTES

Kit para dientes largos /
gran abertura de boca
REF. 300.34



Kit para dientes cortos /
pequeña abertura de boca
REF. 300.56



- ▶ Menos traumático en la implantología, los extractores minimizan las pérdidas óseas al evitar el uso de brocas. Los dolores postoperatorios se reducen y es posible reimplantar en la misma sesión.
- ▶ En caso de osteointegración avanzada, desestabilizar el implante de la mesa ósea con ultrasonidos. Alternativamente, usar los extractores derecho e izquierdo para separarlos gradualmente del hueso.
- ▶ Para un implante poco osteointegrado, atornillar el extractor izquierdo en el implante para levantarlo.

EXTRACTOR DE TORNILLOS



REF. 300.12

El extractor de tornillos permite levantar un tornillo dañado girando a la izquierda (use previamente un taladro Ø 0,6 mm. para hacer un agujero en el tornillo).



El destornillador se adapta a los contraángulos o al adaptador universal. (ref. 300.09)

IMPLANTOLOGÍA

EXTRACTORES

ADAPTADOR UNIVERSAL



ADAPTADOR UNIVERSAL
para los destornilladores de contraángulos.
REF. 300.09

LLAVE DE CARRACA DINAMOMÉTRICA



LLAVE DE CARRACA DINAMOMÉTRICA
10/40 N/cm
REF. 300.01

KIT LLAVE + ADAPTADOR



KIT LLAVE + ADAPTADOR
REF. 300.19

KIT LLAVE + 2 EXTRACTORES DE IMPLANTES



LARGOS
REF. 300.20

CORTOS
REF. 300.21

KIT DE EXTRACCIÓN DE TORNILLO



Con 1 extractor de tornillo y 1 fresa esférica.
REF. 300.27



Con 1 llave, 1 adaptador, 1 extractor de tornillo
y 1 fresa esférica.
REF. 300.26



KIT DE EXTRACCIÓN



Con 1 llave, 1 adaptador, 2 extractores de implantes, 1 extractor de tornillo,
1 fresa esférica y 1 bandeja de esterilización.
REF. 300.24 - con extractores largos
REF. 300.25 - con extractores cortos



Vea el video
clínico en

YouTube



ORTODONCIA

Separadores.....	86
Mezclador de Cera y Alginatos.....	87
Alicates.....	88
Instrumentos Varios.....	90
Accesorios Varios.....	91

ORTODONCIA

MODELOS Y SEPARADORES

SEPARADORES DE MEJILLA



ADULTO
REF. 151.20



ADULTO
REF. 151.40



ADULTO
REF. 151.30

CON RETENCIÓN LINGUAL



NIÑO
REF. 151.21



NIÑO
REF. 151.41



NIÑO
REF. 151.31

CON RETENCIÓN LINGUAL

Todos los separadores se venden por unidad.

ORTODONCIA

MEZCLADOR DE CERA Y ALGINATOS

MEZCLADOR DE ALGINATOS

**MEZCLE TODOS TUS
ALGINATOS EN 5 SEGUNDOS
¡ SIN BURBUJAS !**

ECONÓMICO, SIMPLE, RÁPIDO E HIPOALERGÉNICO

**ATRACTIVO, DISCRETO,
PESO LIGERO, PEQUEÑO TAMAÑO,
FÁCIL DE UTILIZAR.**



REF. 3055.03



REF. 3055.02



REF. 3055.01

Garantía: 18 meses.

Peso: 18 kg.

Dimensiones: 20x24x30 cm.

Dotado de 4 cuencos, 1 botella dosificadora, 1 espátula y 1 mezclador.
REF. 3055.00



ORTODONCIA

ALICATES

MALLOTHY



Alicates para doblar alambres y ganchos
REF. 877.00

Alicates para todos los ganchos, incluso redondos, con dos series de muescas, en los extremos y en las bases de la tenaza para retener y estabilizar los hilos. El diámetro de hilo máximo aceptado es de 0,7 mm. Muy prácticos gracias a su tamaño reducido (10 cm.), y a su combinación de las cualidades de las pinzas Aderer (finura), y Waldsachs (robustez).

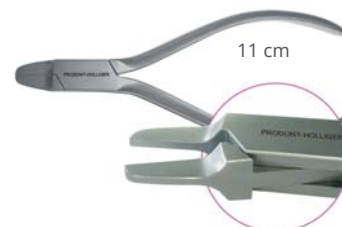

Alicates para doblar arcos
REF. 801.00

ADERER

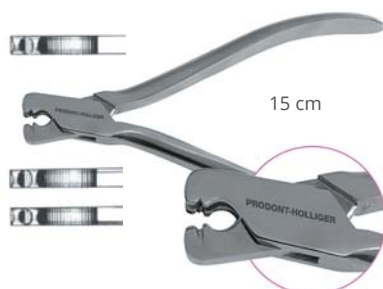

Alicates para doblar barras
REF. 886.00

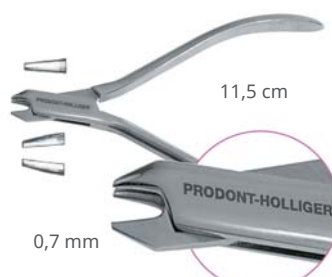

REF. 882.00



REF. 881.00

YOUNG

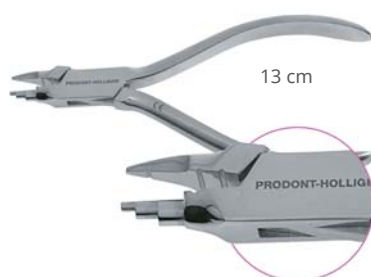

REF. 878.00

ANDRESEN

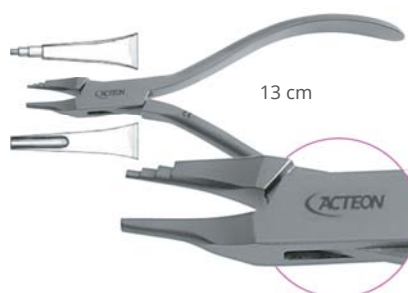

REF. 880.01

TWEED



Alicates para formar ondulaciones
REF. 880.00

ALICATES REMOVEDORAS DE BRACKETS



REF. 802.00

ORTODONCIA

ALICATES

ALICATES DE CORTE

CARBURO DE TUNGSTENO (TC) : RESISTENCIA AL DESGASTE
NITIDEZ Y LONGEVIDAD.

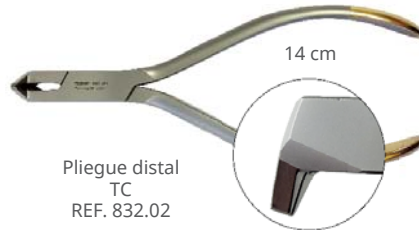

HOW

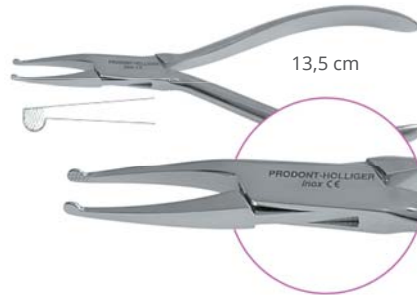

WEINGART



ADAMS

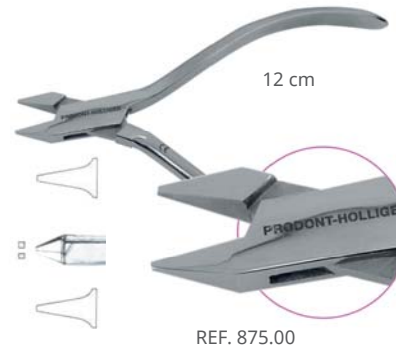

HOLLOW CHOP

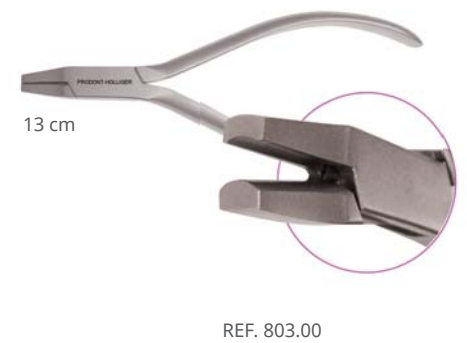

WALDSACHS



ANGLE

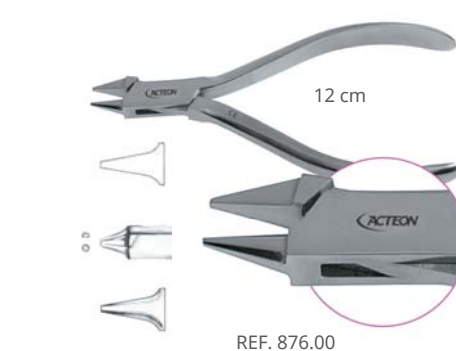

CINCH BACK



ORTODONCIA

INSTRUMENTOS VARIOS

PORTAAGUJAS MATHIEU



TIJERAS PARA CORONAS



ALICATES DE ABRAZADERA



ASENTADORES DE BANDAS



PINZAS ORTODÓNCICAS



ESPÁTULAS PARA HILOS



ELIJA SU MANGO



ORTODONCIA

ACCESORIOS VARIOS

CUCHILLOS PARA CERA



FAHNSTOCK
REF. 2067.16



REF. 2065.17

RECIPIENTES

RECIPIENTE
DE SILICONA
FLEXIBLE.



10 ml
REF. 1595.03

RECIPIENTE
DE VIDRIO
DAPPEN.



10 ml / 2 ml
REF. 1592.00

CALIBRE PIE DE REY



Calibre pie de rey orto.

REF. 3331.02



Calibre pie de rey digital de acero inoxidable.

REF. 3331.01

REF. 3331.00



Calibre pie de rey de acero inoxidable.



ACCESORIOS

Cuencos - Gafas de Protección - Accesorios Varios.....	94
Espátulas - Cuchillos - Instrumentos para Tallado - Discos.....	95
Bandejas.....	96
Limpiadores de Ultrasonidos	97
Mecheros	98
Bandeja de Acero Inoxidable - Easybacs.....	99

ACCESORIOS

CUENCOS - GAFAS DE PROTECCIÓN - ACCESORIOS VARIOS

CUENCOS

CUENCOS DE PLÁSTICO PARA ALGINATOS.



Ø 12 cm, H 9,5 cm
REF. 1599.00

Ø 10 cm, H 7,5 cm
REF. 1598.00

Ø 8 cm, H 6 cm
REF. 1597.00

CUENCOS EXTRAFLEXIBLES.



Ø 13 cm, H 9 cm
500 ml
REF. 1596.00

Ø 10 cm, H 6 cm
250 ml
REF. 1596.01

Ø 8 cm, H 5 cm
100 ml
REF. 1596.02

FÓRCEPS



REF. 2254.01

MILLER



REF. 433.00

SOPORTES ENDODÓNCICOS



VERDE
REF. 3121.10

AZUL
REF. 3121.11



Regla milimetrada.
8 compartimentos.
Ensamblaje para múltiples soportes.

ESTERILIZACIÓN
A 135°

CEPILLOS DE LIMPIEZA



REF. 2190.00

GAFAS DE PROTECCIÓN



REF. 3520.00

ACCESORIOS

ESPÁTULAS - CUCHILLOS - INSTRUMENTOS PARA TALLADO - DISCOS

ESPÁTULAS



REF. 4520.00



REF. 4518.00



REF. 4527.00



REF. 4515.07E

CUCHILLO MAMMOUTH



REF. 1996.00.

CUCHILLO GRITMAN



REF. 1997.00

INSTRUMENTOS PARA TALLADO DE CERA - PETER THOMAS PKT



Ø 1,2 mm

Ø 0,9 mm

REF. 175.01E

DISCOS

Discos abrasivos ultrafinos para cerámica y metal.



REF. AP2202612PH
x100

Discos para cortar metal.



ALTA VELOCIDAD
REF. AP2206011PH
x100

Discos separadores ultrafinos reforzados.



REF. AP2502R.
x20

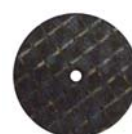

REF. AP2502RC.
x20

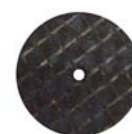

REF. AP2503R
x20



REF. AP2503RC.
x20

ACCESORIOS

BANDEJAS

BANDEJAS



Easyclip



8 instrumentos.
180x136x30 mm.
Material: PSU
90 g.
REF. 233.30



Acero inoxidable.
Bandeja grande.
18x28x3 cm.
1000 g.
REF. 233.25



Bandeja esterilizable.
(16x10,5x5 cm.)
10 tapones + 1 recipiente.
REF. 300.02



ESTERILIZACIÓN
A 180°



Silicona verde
4 instrumentos
REF. 233.16

Silicona amarilla
10 instrumentos
REF. 233.17

Bandeja de acero inoxidable
18x13x2,5 cm. con silicona,
para 4 compartimentos.

REF. 233.13

Bandeja de acero inoxidable
18x13x2,5 cm. con silicona,
para 10 compartimentos.

REF. 233.14

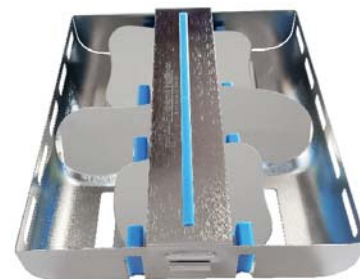

Bandeja para espejos
fotográficos
(se vende sin los espejos)
(18,5x16,5x3,5 cm)
para 3 espejos o
2 espejos + mango.

REF. 233.19

ACCESORIOS

LIMPIADORES DE ULTRASONIDOS

HIGIÉNICO: Panel de control de aluminio.

SILENCIOSO: Gracias a su cubierta en PEHD .

Estructura de acero inoxidable / **2 AÑOS DE GARANTÍA.**

Interruptor estanco y reforzado.



Incluye: 2 canastillas
+ 1 tubo de salida

Tipo	Volumen	Dimensiones cuba (cm)	Dimensiones externas (lxLxH cm) (grifo cerrado)	Frecuencias	Potencia ultrasónica	Potencia del calentador	Temporizador (min)	Temperatura	
PH300N.	3 L	20x11x5	28x18x21	40 kHz	120 W	/	1-99	/	
PH300CN						150 W		20-60°C	
PH500N.	5 L	20x11x9	28x18x26			/		150 W	20-60°C
PH500CN						150 W			

ACCESORIOS

MECHEROS

AIR HOLY

NUEVO MECHERO DE AIRE CALIENTE



REF. FU37/2000R

- ▶ Sin llama ni gas.
 - ▶ Calienta todo tipo de instrumentos.
 - ▶ Ablanda la cera de manera uniforme, sin quemaduras.
 - ▶ Rápido y fácil de utilizar.
 - ▶ Sin obturación de la extremidad. El aire aleja las gotas de cera.
-
- ▶ Luz LED de encendido.
 - ▶ Peso: 640 g - Dimensiones: 26x11x7 cm.
 - ▶ Temperatura: 300 °C. Presión de Aire: 0,5 bar.
 - ▶ Cumple con las normas ROHS y DEEE.
- Alimentación monofásica 230V - 50 Hz con una tierra clase I.
Potencia: 200W - Intensidad máx.: 1 Amp.

PROTORCH 4



- ▶ Más fiable, más constante.
- ▶ Llama precisa y ajustable.
- ▶ Muy sencillo de encender gracias al sistema de encendido automático "piezo".

PRECAUCIÓN: para garantizar un uso y una vida útil óptimos, recargue Protorch SOLAMENTE con MINIFLAM 400 ml. REF. 47/1602 (mezcla de butano/propano especialmente estudiada y purificada, vendido por separado).

REF. FU47/1602



1h20

1300°C
2370°F

REF. FU31/0404

Recargando al revés.

Encendido.

OFF

HOLY NOMADE

Cartucho de gas
REF. FU47/1621



REF. FU37/1195

LA POTENCIA DE UN MECHERO EN CUALQUIER LUGAR DONDE LO NECESITE.

Configuración independiente de llama y llama tipo lamparilla.

⊖ AUTONOMÍA
Llama: 1h
Lamparilla: 2h

Cartucho de gas vendido por separado.

LÁMPARA DE ALCOHOL



REF. 3605.00

Mecha para lámpara de alcohol (1 metro)
REF. 2077.00

ACCESORIOS

BANDEJAS DE ACERO INOXIDABLE - EASYBACS

BANDEJA DE ACERO INOXIDABLE

PERSONALICE SUS BANDEJAS CON GRAVADO LÁSER.
A PARTIR DE 20 PCS.



20x15 cm
REF. 233.15



20x10 cm
REF. 233.10

EASYBACS

CLASIFIQUE SUS PRÓTESIS POR PACIENTE

Cómodos - Diseño agradable - Robustos - Apilables

Desde su espacio de almacenamiento hasta la colocación en el armario.

22x16x5 cm



REF. 233.42



REF. 233.43



REF. 233.44



GAMA LABORATORIO

CATÁLOGO GAMA LABORATORIO

Tenemos disponible un catálogo de productos **PRODONT HOLLIGER** especializado en laboratorio:



The image shows the cover of a laboratory catalog. The top half has a dark background with a circular object and a dental tool. The text 'I AM ACCURATE' is written in large, white, sans-serif letters. Below this, on a white background, are several dental instruments: a handpiece, a pencil, two pairs of tweezers, a scalpel, and a pair of pliers. The Acteon logo is visible on the pliers. The text 'Innovación', 'Calidad', and 'Rendimiento' is stacked vertically. Below that is 'Catálogo Laboratorio'. The Acteon logo is at the bottom right.

I AM
ACCURATE

Innovación
Calidad
Rendimiento

Catálogo Laboratorio

ACTEON



Descargue aquí,
nuestro catálogo
PRODONT HOLLIGER
dedicado a
LABORATORIO.

TECNOLOGÍA PURE REFLECT®

Exclusiva de ACTEON PRODONT-HOLLIGER.

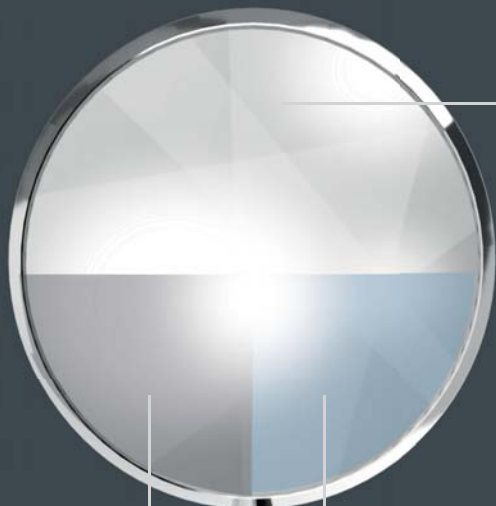

RODIO
Reflejo grisáceo.

TITANIO
Reflejo azulado.

**Inspirado por la
industria aeroespacial.**

Sin distorsión (reflejo en capa superior).



Luminosidad óptima.



Sin distorsión de color ni de forma.
Imagen precisa y nítida.

El auténtico reflejo de color

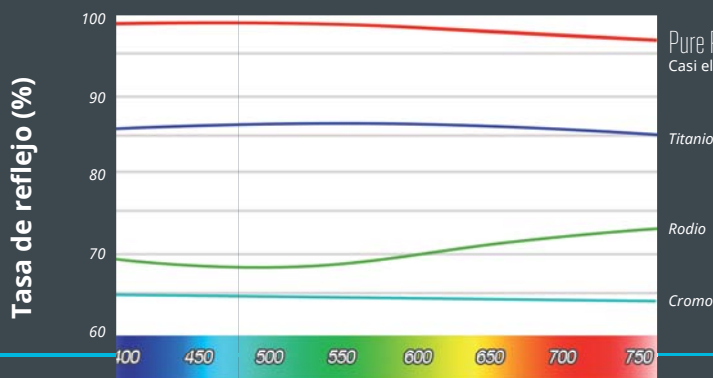

Pure Reflect®
Casi el 100% de la tasa de reflejo

Titanio

Rodio

Cromo

Longitudes de onda visibles (nm)

*Fuente: laboratorio CNRS - Francia 12/2013

CATÁLOGOS

CATÁLOGOS PRODONT HOLLIGER

Tenemos disponibles varios catálogos de **PRODONT HOLLIGER**:

- ▶ Catálogo de productos para laboratorio.
- ▶ Catálogo de la gama de instrumentos premium **BLISS**.
- ▶ Catálogo de la gama de espejos.
- ▶ Catálogo de bandejas endocirugía.
- ▶ Folleto resumen de los productos **PRODONT HOLLIGER** más destacados.



SITIO WEB PRODONT HOLLIGER

Pueden acceder a nuestra página web para descargar cualquiera de estos catálogos en versión digital o para obtener más información sobre cualquiera de nuestros productos **PRODONT HOLLIGER**.



Página web
Prodont-Holliger



www.akteongroup.com/es

Estos productos sanitarios son de clase I, con la excepción de los osteótomos y las tijeras para hueso de clase Im, según el tipo (organismo notificado KIWA - CE0476), según la Directiva Europea 93/42/CEE y disponen de marcaje CE. Estos productos sanitarios para el cuidado dental están reservados para el personal de salud; no son reembolsados por las organizaciones de seguros de salud. Estos materiales se han diseñado y fabricado de acuerdo con un sistema de garantía de calidad certificado según la norma EN ISO 13485.

Fabricante: PRODONT HOLLIGER - Grupo ACTEON (Francia).